

Ball Rail Tables TKK

with Ball Rail Systems
and Ball Screw Drive

R310EN 2501 (2008.04)

The Drive & Control Company

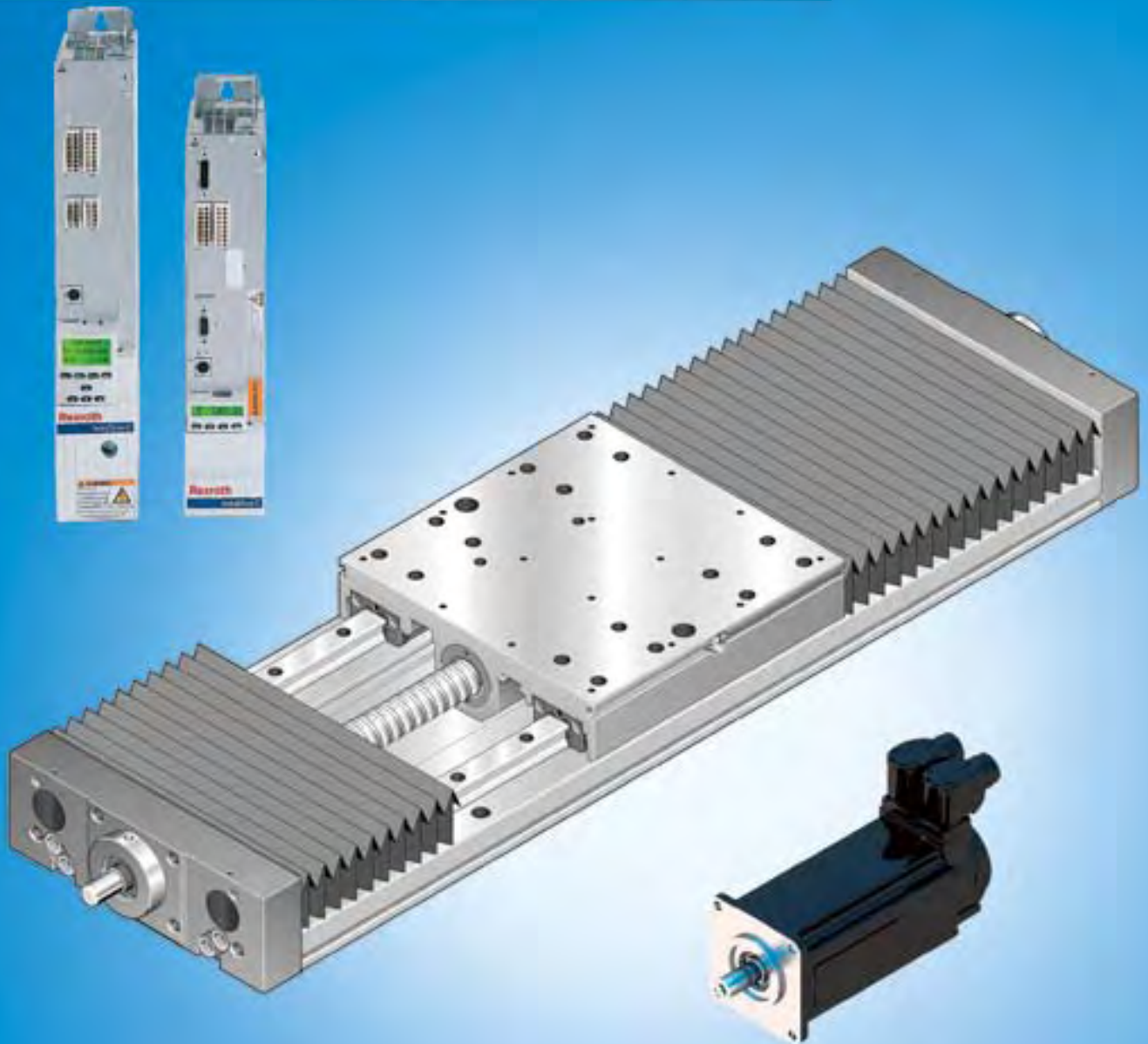

Linear Motion and Assembly Technologies

Ball Rail Systems
Roller Rail Systems
Linear Bushings and Shafts

Ball Screw Drives
Linear Motion Systems

Basic Mechanical Elements
Manual Production Systems
Transfer Systems

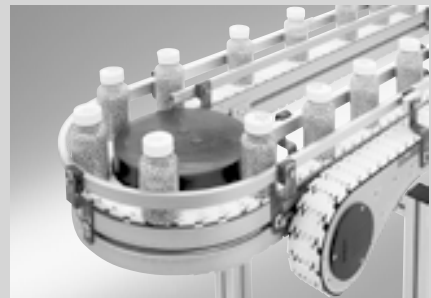
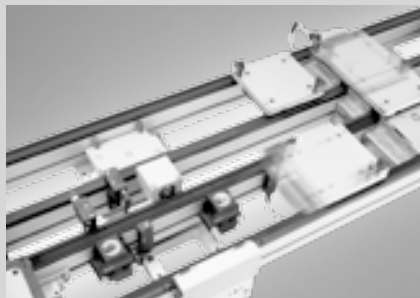
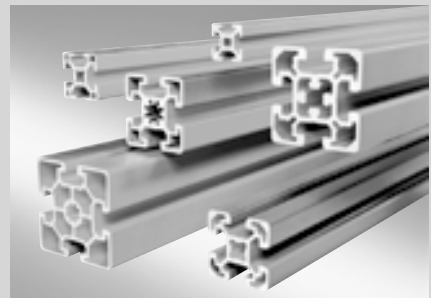
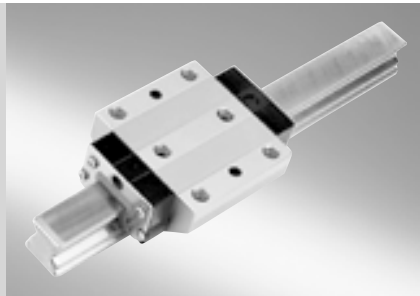
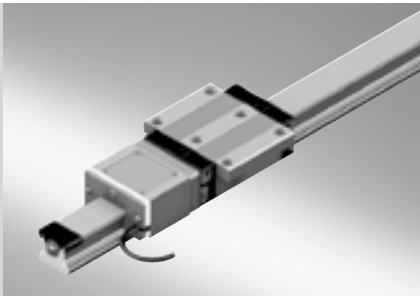

Ball Rail Tables TKK

A Solution to Many Problems	4
Product Overview	6
Motor selection	8
Type designation, sizes	10
Structural Design	12
Fixing, Accuracy	14
Technical Data	16
General system data	16
Specifications of timing belt side drive, floating bearing end	19
Permissible travel speed	20
Maximum permissible drive torque, fixed bearing end	21
Calculations	22
Calculation principles	22
Calculation example	24
TKK 15-155 AI	26
TKK 20-225 AI	32
TKK 20-225 St	36
TKK 30-325 AI	42
TKK 30-325 St	46
TKK 35-455 AI	52
Switch Mounting Arrangements	58
Motors	60
Accessories	62
Documentation	62
Mounting accessories	65
Lubrication	66
Connection System	67
Order Example	72
Inquiry/Order Form	73

A Solution to Many Problems

The tasks

- Driving
- Transporting
- Positioning

Length

Load capacities and moments

Static load

Travel speed

Precision

Linear motion system
with drive unit

Switch mounting arrangements

Multiple axis unit

Accessories

Documentation

Up to 2860 mm

Load capacity C up to 180,600 N

Dyn. longitudinal moment load capacity M_L up to 24,740 Nm

Dyn. torsional moment load capacity M_t up to 27,090 Nm

Up to 2500 kg

Up to 1.6 m/s

Repeatability up to 0.005 mm

Positioning accuracy up to 0.01 mm

Linear guidance accuracy up to 0.007 mm

AC servo motor or stepping motor with mount,
coupling or timing belt side drive; complete with
controller and control system

Mechanical and proximity switches
over the entire travel range

Combination option provided by connectors

Sliding blocks

Moment of friction measurement, Lead deviation
Travel accuracy, Positioning accuracy

The solution

Ball Rail Tables

Product Overview

Ball Rail Tables are precision, ready-to-mount guidance systems with high performance characteristics and compact dimensions. Practical combination options and the modular construction principle make a wide range of economical applications possible.

Fast delivery is a matter of course.

Outstanding features

- Oil and temperature resistant bellows mounting through mechanical clamping of the last folds.
- Easy motor attachment via locating feature and fastening threads.
- High travel speeds over long linear distances due to Ball Rail Systems, large screw diameters and leads, and double floating bearings.
- No loss of load capacity thanks to rigid table design, reference edge for runner blocks, parallel drilled nut mounting.
- Increased load-bearing capacity generally permits the use of a smaller Ball Rail Table.
- Low-cost maintenance of the four runner blocks and the Precision Ball Screw Assembly. Lubrication via one central lubrication point. A lube port is readily accessible on each side of the carriage. Suitable for grease lubrication only.
- High precision ball runner blocks.
- Switches adjustable over the entire travel range. Can be mounted either internally, protected by the bellows, or externally, in freely accessible positions.
- Rapid mounting thanks to machined reference edge on the base plate.
- Integrated components protected by high-quality, welded, oil- and moisture-resistant bellows.

Structural design

- Base plate made from precision machined aluminum profile or steel with reference edge in finely graduated length increments
- Guideway: Ball Rail Systems with four long runner blocks per carriage
- Precision ball screw drive in tolerance grade 7 with zero-backlash nut system
- Aluminum fixed bearing end-plate with two-row, preloaded angular-contact thrust ball bearing
- Floating bearing end-plate with double floating bearing system
- Carriage made of machined aluminum profile or steel in various lengths

Attachments

- Bellows
- Internal glass scale
- Internal or external mechanically operated switch
- Internal or external proximity switch
- Socket with mating plug for the switches
- Aluminum profile cable duct
- Timing belt side drive or motor mount and coupling for attachment of the motor
- 3-phase stepping motors
- Maintenance-free digital AC servo motors with integrated brake and attached feedback

High precision ball runner blocks

(available from 3rd quarter 2008)



Direct comparison of the travel accuracy of two ball runner blocks

The graph clearly shows that the short-wave inaccuracies (dashed line) can be very significantly reduced by the new, innovative design of the entry zone (continuous line).

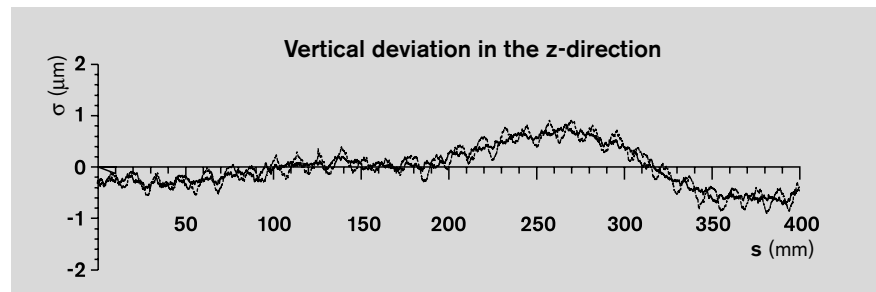

Drive controllers and control systems

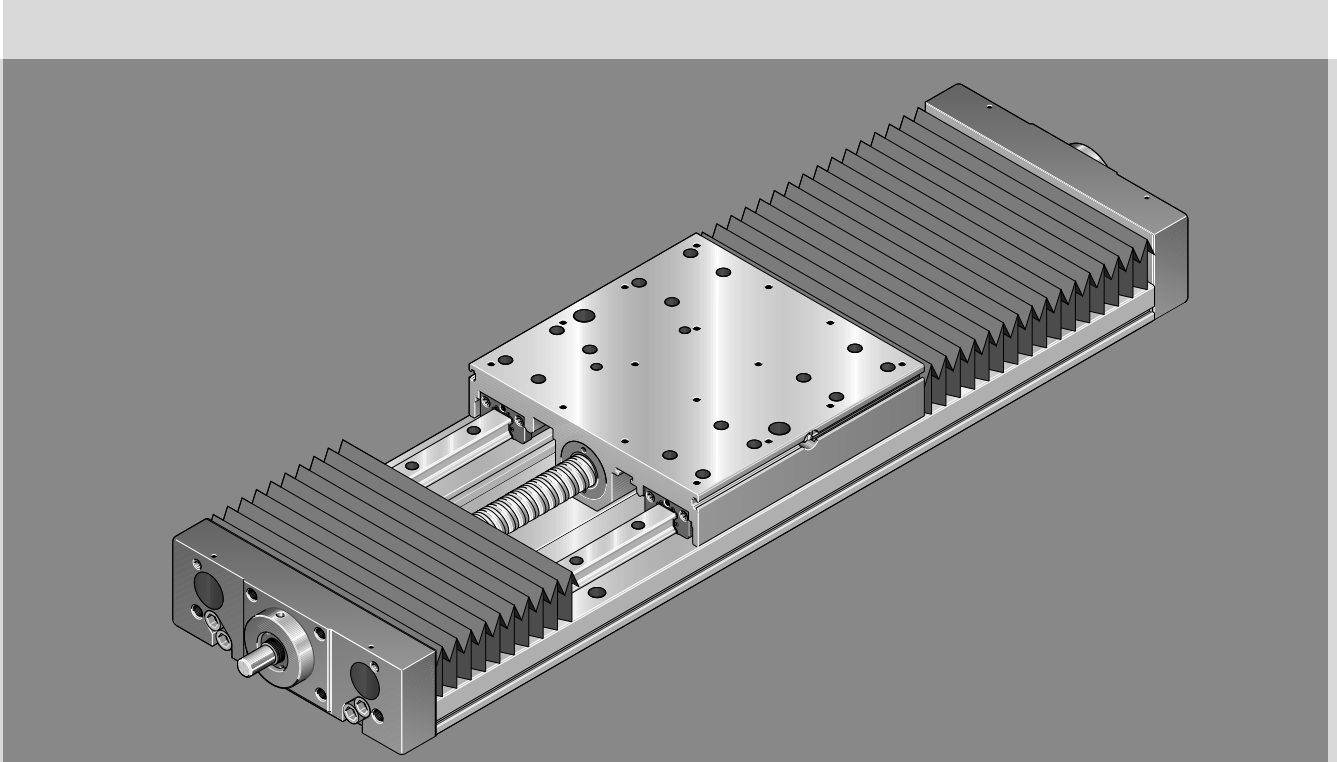

For Ball Rail Tables with two ball rail systems and linear motor, see separate catalog "Ball Rail Tables TKL."

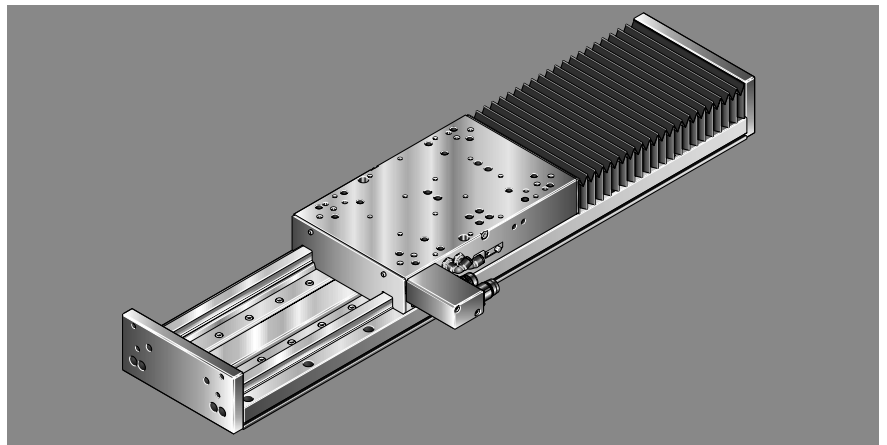

Product Overview

Motor selection based on drive controllers and control system

Several motor-controller combinations are available in order to provide the most cost-effective solution for every customer application.

When sizing the drive, always consider the motor-controller combination.

For more detailed information on motors and control systems, please refer to the catalogs "ECODRIVE Cs" and "IndraDrive for Linear Motion Systems."

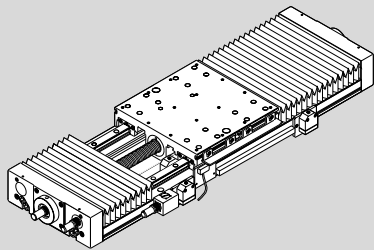

Digital AC servo motors

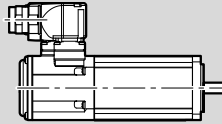

MSK

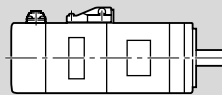

MSM

3-phase stepping motors

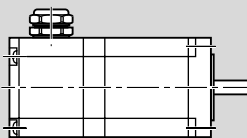

**VRDM 397
VRDM 3910
VRDM 3913**

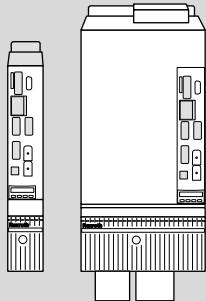

IndraDrive C

Digital controller
Power unit HCS
Control unit CSH

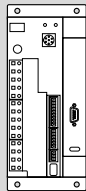

DKC

Digital controller
ECODRIVE Cs
Compact and dynamic solution
for lower power ranges

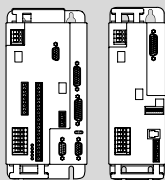

Twin Line

Power electronics
Stepping motor output stage with
or without integrated controller

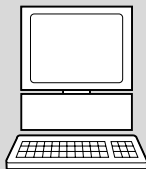

PC

PC controller board
Stepping motor controller



**PROFI-
step**

**Single- and multi-axis
positioning control with
power output module**
The complete solution

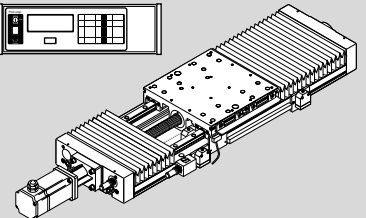
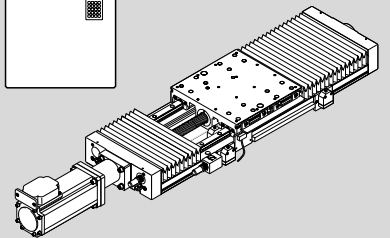
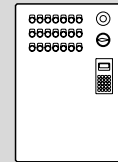

Ball Rail Tables can be supplied complete with motor, controller and control system.

Product Overview



Type designation

The Ball Rail Tables are designated according to **type** and **size**.

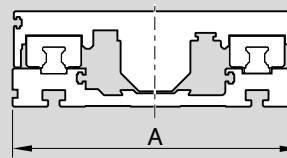
Types also cover the equivalent designs without drive units.

		Type	Size
Ball Rail Table (example) =		T K K	20-225 Al
System	= Ball Rail Table (T)		
Guideway	= Ball Rail System (K)		
Drive unit	= Ball Screw Drive (K)		
Dimensions of guideway	= 		
Frame size	= 		
Material	= Aluminum profile Steel		

Type designation, sizes

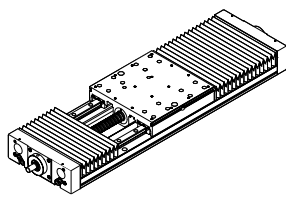
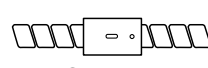
	Type	Guideway	Drive unit	Ball Rail Table
Ball Rail Tables	TKK	 Ball Rail Systems	 without drive unit	
			 Ball Screw Drive	

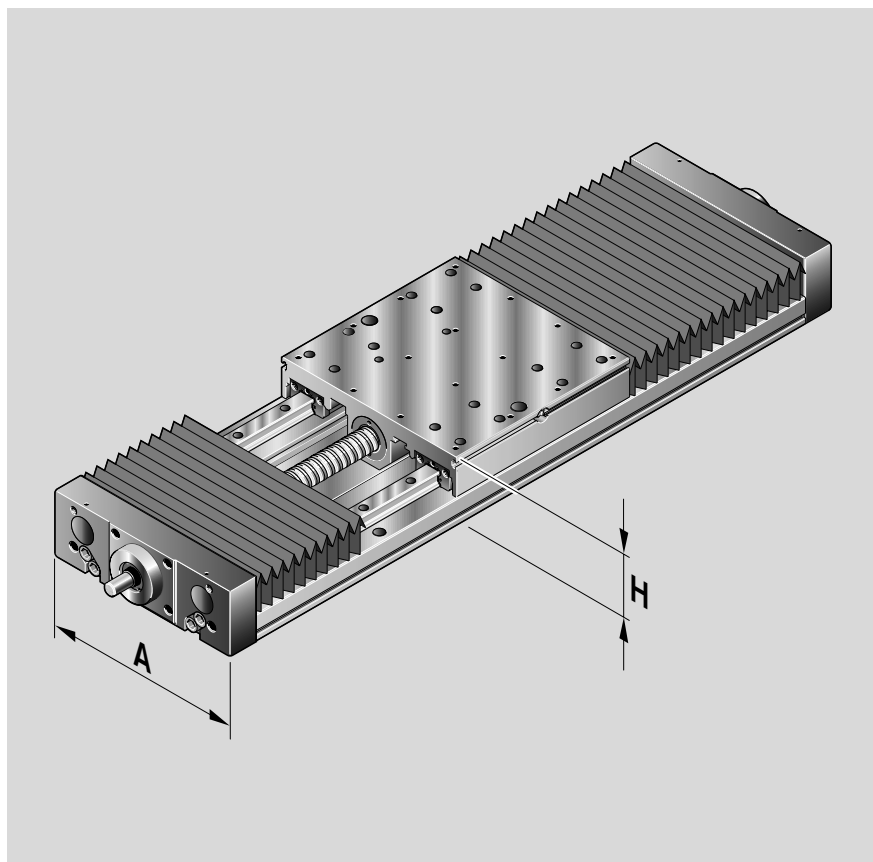

	Size	Dimensions A x H (mm)	L _{max}	Dyn. load capacity C (N)
	TKK 15 - 155 Al	155 x 60	2860	25 300
	TKK 20 - 225 Al	225 x 75	2860	79 200
	TKK 20 - 225 St		2380	
	TKK 20 - 225 Al	225 x 105	2860	
	TKK 30 - 325 Al	325 x 90	2860	129 960
	TKK 30 - 325 St		2380	
	TKK 30 - 325 Al	325 x 120	2860	
	TKK 35 - 455 Al	455 x 120	2860	180 600

Structural Design

- 1 Fixed bearing end-plate
- 2 Bellows, two-part
- 3 Ball screw with zero-backlash single nut
- 4 Carriage with 4 long runner blocks
- 5 Floating bearing end-plate
- 6 Base plate

Attachments

- 7 Mechanical switch, external
- 8 Cable duct
- 9 Switching cam
- 10 Proximity switch, external
- 11 Socket-plug for external switches
- 12 Mechanical and proximity switches, internal
- 13 Socket-plug for internal switches
- 14 Profiled support
- 15 Motor
- 16 Motor mount and coupling
- 17 Timing belt side drive

Aluminum Ball Rail Tables

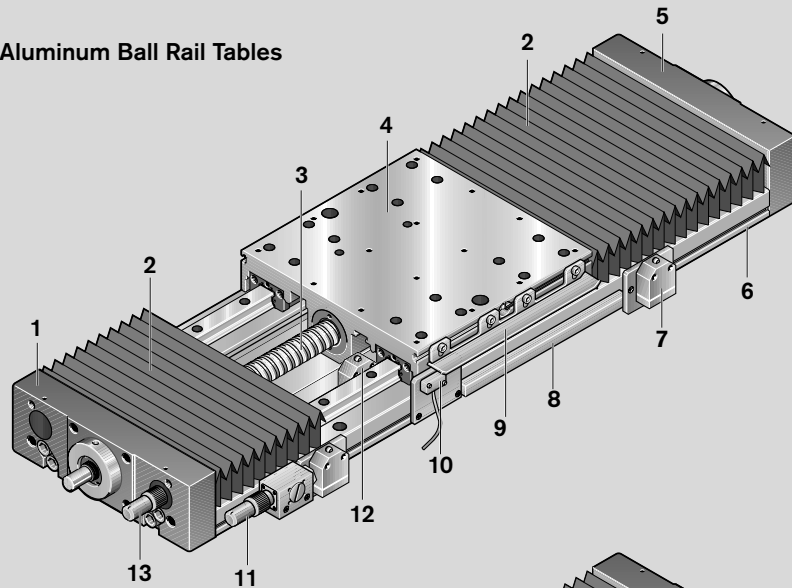

Steel Ball Rail Tables

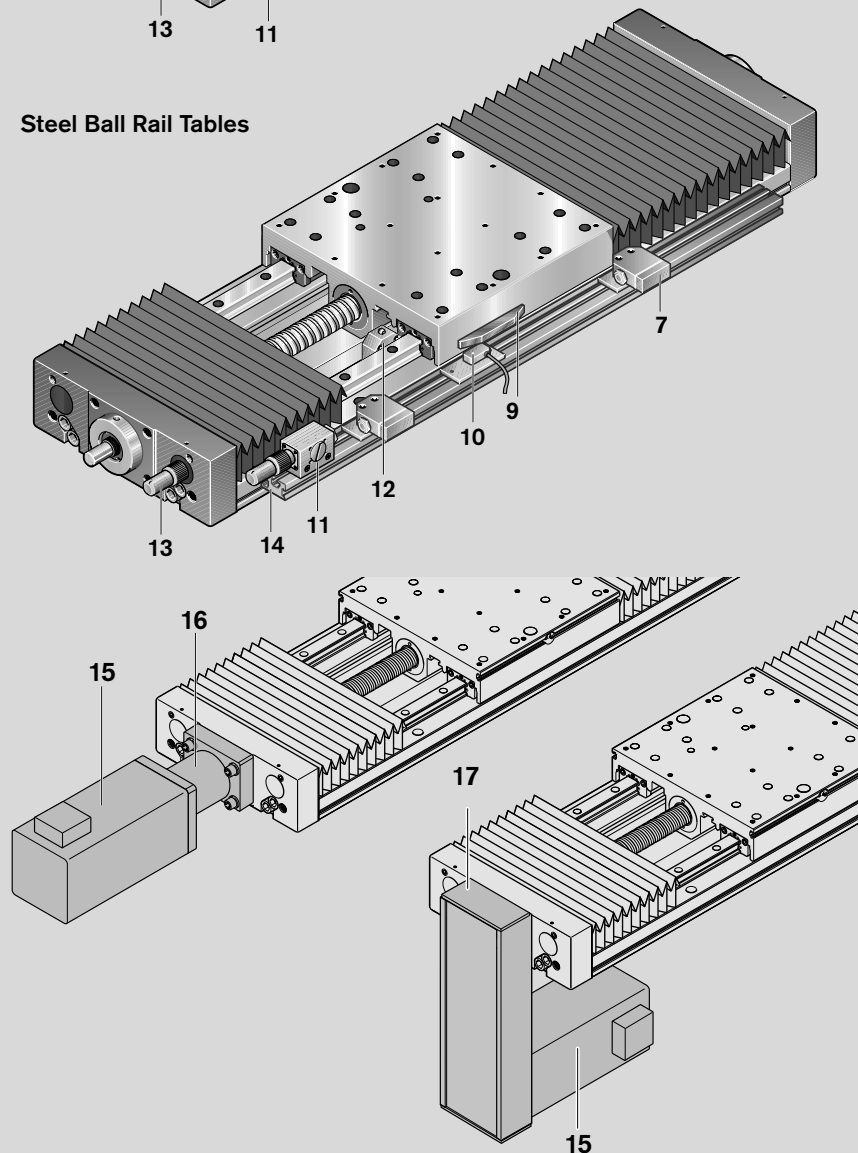

Motor mount and coupling

A motor can be attached to all Ball Rail Tables by means of a motor mount and coupling.

The motor mount serves to fasten the motor to the Ball Rail Table and acts as a closed housing for the coupling. The motor's drive torque is transmitted stress-free through the coupling to the Ball Rail Table's drive shaft.

Our standard couplings compensate for the thermal expansion of the system. If other makes of couplings are used, their thermal expansion must be taken into account.

- 1 Motor
- 2 Motor mount
- 3 Coupling
- 4 Ball Rail Table

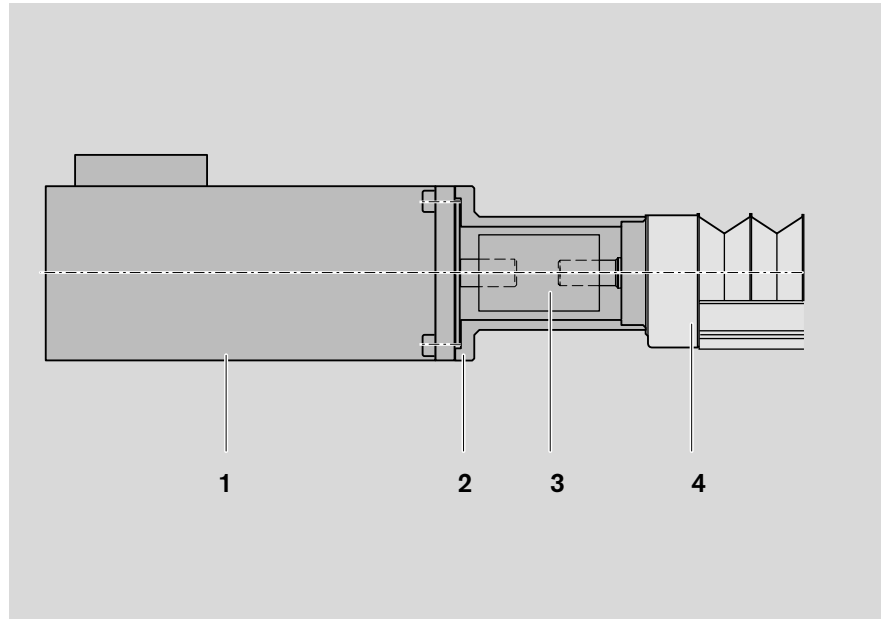

Timing belt side drive

All Ball Rail Tables offer the option of attaching the motor via a side drive with timing belt.

This makes the overall length shorter than when attaching the motor with a motor mount and coupling.

The compact, closed housing serves as protection for the belt and as a motor bracket. Different gear ratios are available:

- $i = 1$
- $i = 1.5$
- $i = 2$

The timing belt side drive can be mounted in four different directions:

- below, above (RV05 and RV06)
- left, right (RV01 to RV04)

- 1 Ball Rail Table
- 2 Housing made of drawn, anodized aluminum profile
- 3 Toothed belt
- 4 AC servo motor
- 5 Pre-tensioning of the toothed belt:
Apply pretensioning force F_v to motor
(F_v will be indicated on delivery)
- 6 Belt pulleys attached using tensioning units
- 7 Cover plate
- 8 End cover

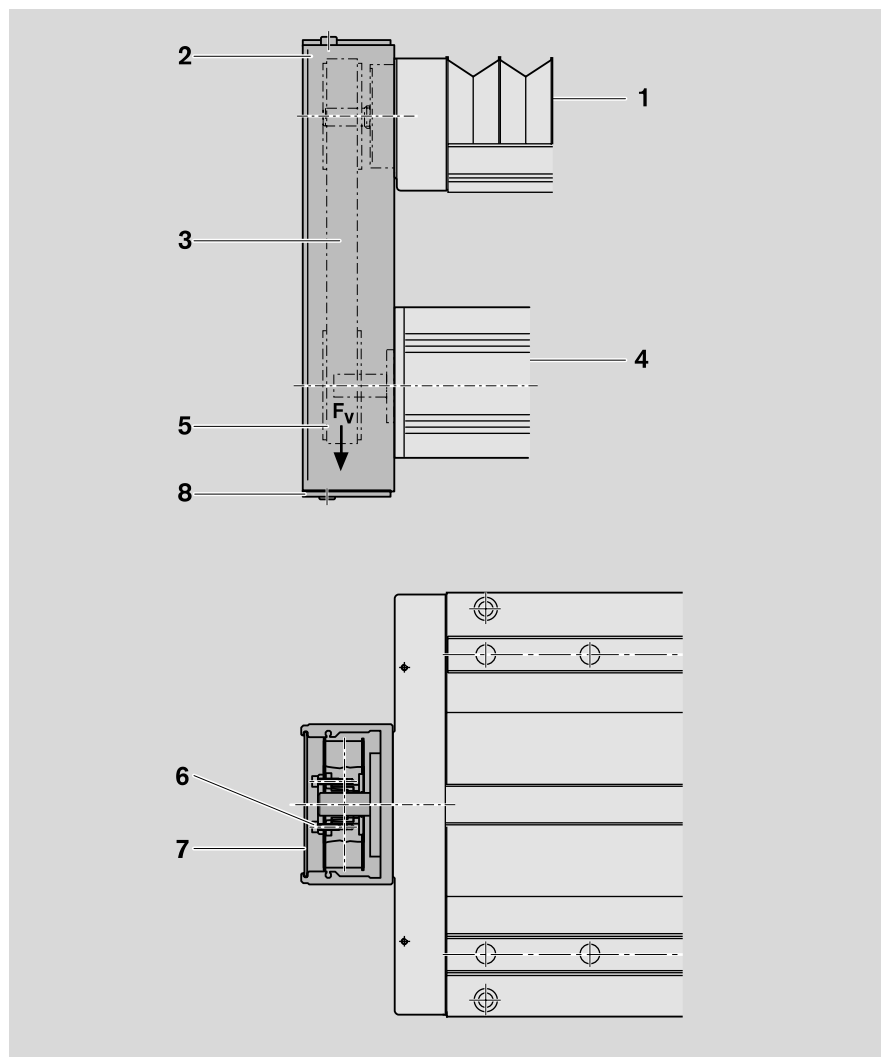

Fixing, Accuracy

General notes on mounting

The aluminum Ball Rail Tables can be secured from above or below.

The steel Ball Rail Tables can only be mounted by bolting from above.

In both versions, a reference edge is built into the base plate to help align the unit. Mounting hole plugs are included with the unit.

For installation dimensions, see the relevant dimension drawings.

- a) Plug
- b) Base plate
- c) Reference edge
- d) $R_{max.} 0.3$
- e) Nut for T-slot (see accessories)

Aluminum Ball Rail Tables

Fixing from above

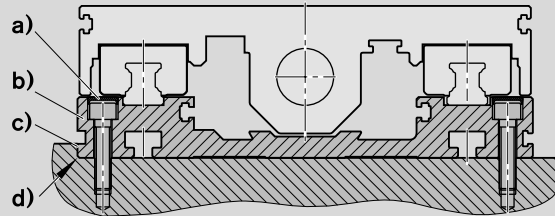

Fixing from below

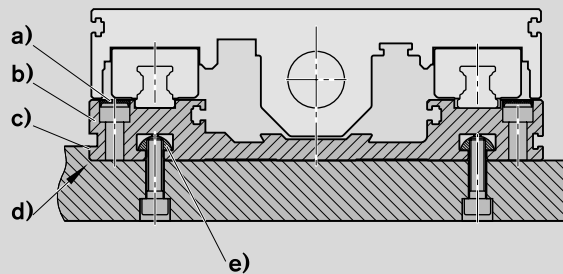

Steel Ball Rail Tables

Fixing from above

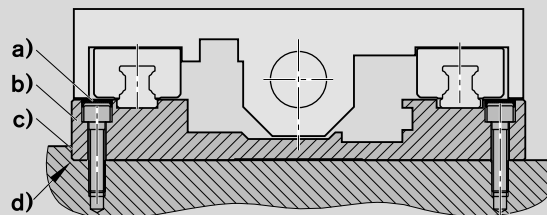

Accuracy

All accuracy data apply to the unit when screwed down and assume an ideal flat mounting base surface. Irregularities in the mounting base surface are not taken into account in the values given below.

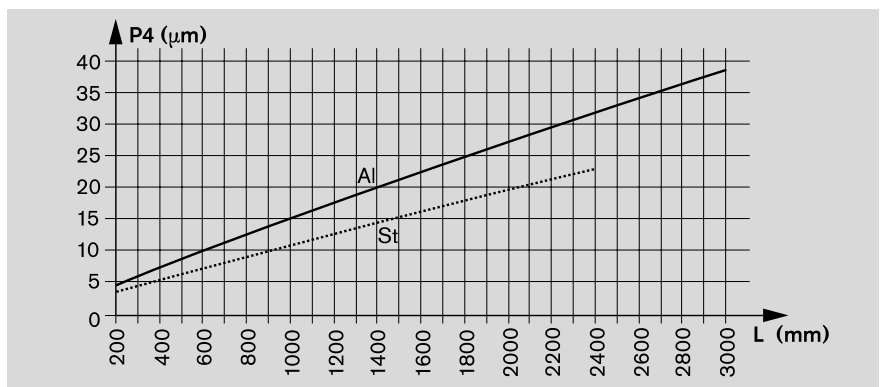
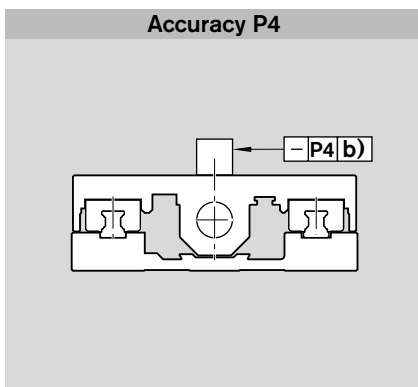
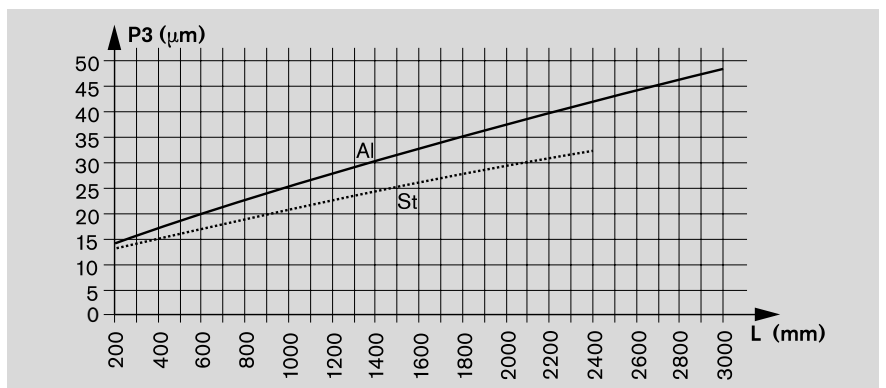
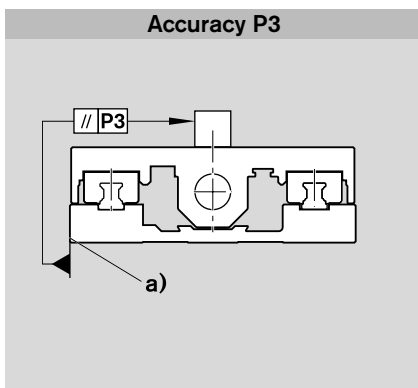
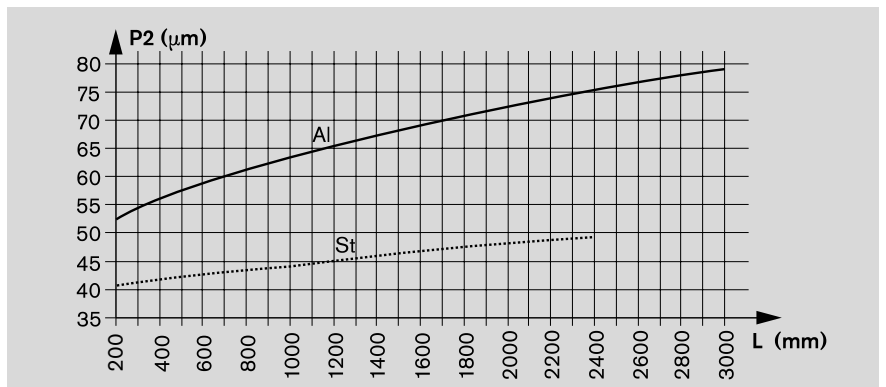
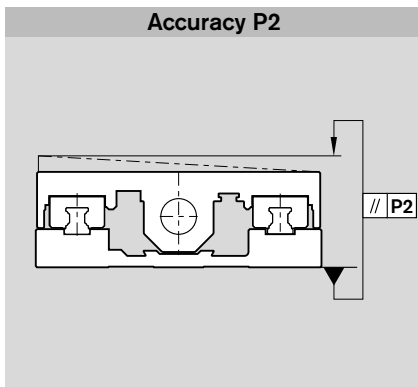
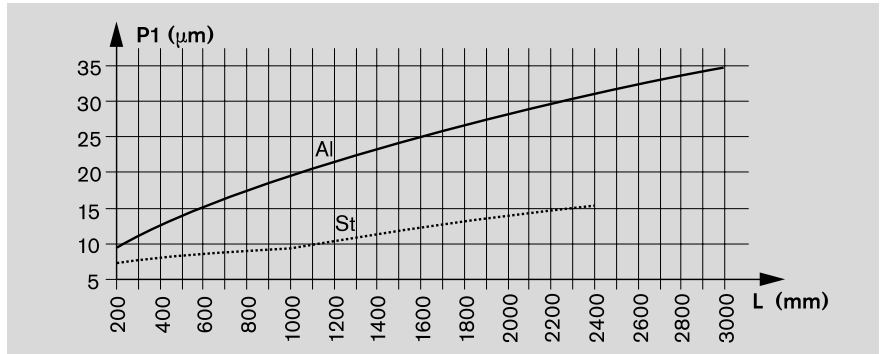
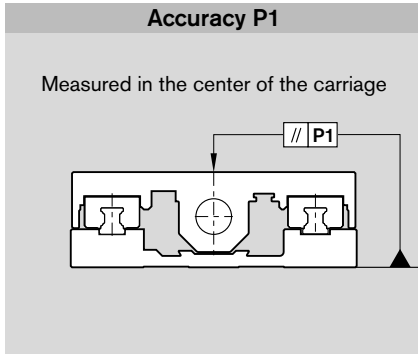

a) Reference edge b) Longitudinal

Technical Data

General system data

Size	Ball screw $d_0 \times P$ (mm)	Dynamic load capacity C (N)			Dynamic load moments (Nm)			Maximum loads (N)		
		Guideway	Ball screw	Fixed bearing	M_t	M_L	M_L	$F_{z1 \max}$	$F_{z2 \max}$	$F_{y \max}$
TKK 15-155 Al	without	25300	-	-	1330	1140	2027	24000	16920	6000
	16 x 10		9600							
	16 x 16		9300							
	20 x 5		14300							
	20 x 20		13300							
TKK 20-225 Al TKK 20-225 St	without	79200	-	-	6340	5073	9037	79200	32160	19800
20 x 5	14300									
20 x 20	13300									
25 x 5	15900									
25 x 10	15700									
25 x 25 ¹⁾	14700									
TKK 30-325 Al TKK 30-325 St	without	129960	-	-	14940	11890	20330	123200	89040	30800
32 x 5	21600									
32 x 10	31700									
32 x 20	19700									
32 x 32	19500									
TKK 35-455 Al	without	180600	-	-	27090	24740	163200	88080	40800	
40 x 5	29100									
40 x 10	50000									
40 x 20	37900									
40 x 40	37000									

1) Al only

Maximum permissible loads

Size	Dimension (mm)	Z_1
TKK 15-155		23.7
TKK 20-225		36.6
TKK 30-325		48.5
TKK 35-455		65.5

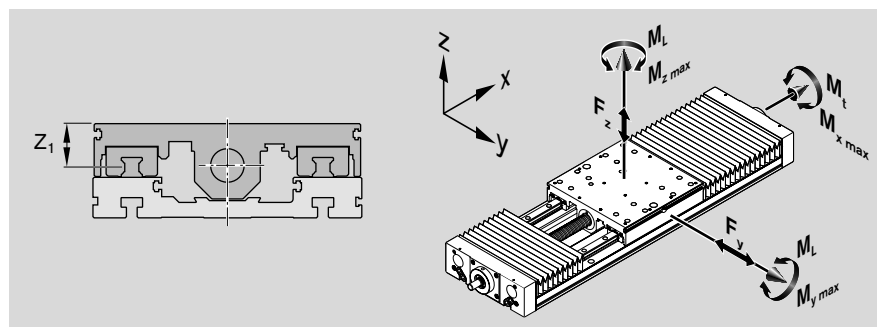

Notes on dynamic load capacities and moments

Determination of the dynamic load capacities and moments is based on a travel life of 100,000 m.
Often only 50,000 m are actually stipulated.

For comparison:
Multiply values **C**, **M_t** and **M_L** from the table by 1.26.
Load ratings for the ball screw as per DIN 69051.

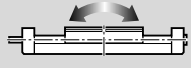
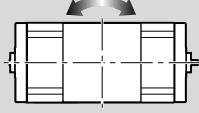
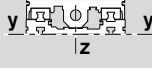
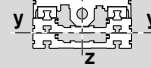
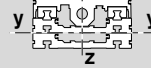
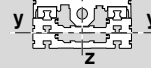
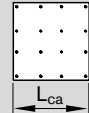
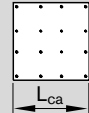
	Maximum loads (Nm)				E · I values (·10 ⁸ Ncm ²)				Moved mass of system m _{ca} (kg)		
	 M _x max	 M _y max	 M _z max		 E · I _y	 E · I _z	 E · I _y	 E · I _z	 L _{ca} = 150	 L _{ca} = 220	
	880	760	1350	270	480	3.07	62.17	-	-	2.3	3.0
										L _{ca} = 220	L _{ca} = 320
										TKK 20-225 Al	
						5.13	196.59	25.27	355.95	7.0	9.0
										TKK 20-225 St	
	2570	2050	3660	1260	2250	9.88	577.03	-	-	13.0	18.0
										L _{ca} = 320	L _{ca} = 450
										TKK 30-325 Al	
						9.92	664.00	45.69	1156.91	17.0	23.0
										TKK 30-325 St	
	10240					17.27	1826.96	-	-	33.5	45.4
										L _{ca} = 450	
	13210	12060				34.71	2554.23	-	-	41.0	

Key to table

- E** = modulus of elasticity
- I_y** = planar moment of inertia referred to the Y-axis
- I_z** = planar moment of inertia referred to the Z-axis
- Z₁** = application point of the effective force

- d₀** = nominal diameter
- P** = lead
- L_{ca}** = carriage length
- Al** = aluminum
- St** = steel

Suitable loads

(recommended values on the basis of past experience)

As far as the desired service life is concerned, loads of up to approximately 20% of the dynamic load and moment values (C, M_t, M_L) have proved acceptable.

At the same time, the following may not be exceeded:

- maximum permissible drive torque
- maximum permissible loads
- maximum permissible speeds (for precise details, see "Technical Data")

Technical Data

Weight

Weight data does not include motor and switch attachments.

- L** = length in mm
- m_{ca}** = moved mass
- Al** = aluminum
- St** = steel
- oA** = without drive (without ball screw and end-plates)
- mA** = with drive (ball screw)

Size	Weight (kg)		Base plate, high	
	Base plate, low			
TKK 15-155 Al	oA	$0.01 \cdot L + m_{ca} - 0.3$		
	mA	$0.0124 \cdot L + m_{ca} + 2$		
TKK 20-225 Al	oA	$0.015 \cdot L + m_{ca} - 0.4$	oA	$0.026 \cdot L + m_{ca} - 0.4$
	mA	$0.018 \cdot L + m_{ca} + 3$	mA	$0.029 \cdot L + m_{ca} + 3$
TKK 20-225 St	oA	$0.040 \cdot L + m_{ca} - 0.4$		
	mA	$0.043 \cdot L + m_{ca} + 3$		
TKK 30-325 Al	oA	$0.029 \cdot L + m_{ca} - 1$	oA	$0.048 \cdot L + m_{ca} - 1$
	mA	$0.035 \cdot L + m_{ca} + 5$	mA	$0.054 \cdot L + m_{ca} + 5$
TKK 30-325 St	oA	$0.070 \cdot L + m_{ca} - 1$		
	mA	$0.076 \cdot L + m_{ca} + 5$		
TKK 35-455 Al	oA	$0.056 \cdot L + m_{ca} - 2.5$		
	mA	$0.066 \cdot L + m_{ca} + 12$		

Friction moments and constants $k_{J\text{ fix}}$, $k_{J\text{ var}}$, $k_{J\text{ m}}$ at the motor journal M_{RS}

- d₀** = nominal diameter of ball screw (mm)
- P** = lead of ball screw (mm)

Size	Ball screw size $d_0 \times P$	Constants			Friction moment M_{RS} (Nm) for guideway preload		
		$k_{J\text{ fix}}$ Short carriage	$k_{J\text{ fix}}$ Long carriage	$k_{J\text{ var}}$	$k_{J\text{ m}}$	2%	8%
TKK 15-155	16 x 10	10.5	12.3	0.039	2.53	0.56	0.58
	16 x 16	19.6	24.2	0.039	6.48	0.58	0.61
	20 x 5	13.6	14.1	0.100	0.63	0.64	0.65
	20 x 20	35.5	42.5	0.100	10.13	0.72	0.75
TKK 20-225 Al	20 x 5	16.6	17.9	0.100	0.63	0.66	0.68
	20 x 20	83.1	103.3	0.100	10.13	0.82	0.90
	25 x 5	35.4	36.6	0.256	0.63	0.82	0.84
	25 x 10	48.7	53.7	0.256	2.53	0.88	0.92
	25 x 25	139.3	170.9	0.235	15.83	1.08	1.17
TKK 20-225 St	20 x 5	20.4	23.5	0.100	0.63	0.66	0.68
	20 x 20	143.9	194.5	0.100	10.13	0.82	0.90
	25 x 5	39.2	42.3	0.256	0.63	0.82	0.84
	25 x 10	63.9	76.5	0.256	2.53	0.88	0.92
TKK 30-325 Al	32 x 5	110.0	113.8	0.712	0.63	1.10	1.12
	32 x 10	142.3	157.5	0.712	2.53	1.29	1.32
	32 x 20	265.3	326.1	0.667	10.13	1.21	1.27
	32 x 32	534	689.6	0.667	25.94	1.36	1.46
TKK 30-325 St	32 x 5	120.5	128.0	0.712	0.63	1.10	1.12
	32 x 10	184.1	214.3	0.712	2.53	1.29	1.32
	32 x 20	432.5	553.0	0.667	10.13	1.21	1.27
	32 x 32	962.0	1270.6	0.667	25.94	1.36	1.46
TKK 35-455	40 x 5	319.2		1.783	0.63	1.66	1.68
	40 x 10	368.2		1.607	2.53	2.32	2.35
	40 x 20	679.7		1.607	10.13	2.24	2.29
	40 x 40	1926.0		1.607	40.53	2.59	2.69

Coupling data

Size	Rated torque of coupling M_{cN} (Nm)	Mass moment of inertia J_c ($\text{kgm}^2 \cdot 10^{-6}$)	Mass of coupling m_c (kg)
TKK 15-155	19	57	0.26
TKK 20-225	19	57	0.26
	50	200	0.7
TKK 30-325	50	200	0.7
TKK 35-455	98	390	0.9

Specifications of timing belt side drive, floating bearing end, for motor attachment via timing belt side drive

Motor type		MSK 040C, MSM 040B				MSK 050C						
Overall dimensions (mm)		51 x 88				66 x 116						
Frictional torque M_{Rsd} (Nm)		0.4				0.45						
Reduction $i = \dots$		Permissible torque up to length $L = \dots$ at ⁽¹⁾		Reduced mass moment of inertia at		Permissible torque up to length $L = \dots$ at ⁽¹⁾			Reduced mass moment of inertia at			
		$i = 1$	$i = 1.5$	$i = 1$	$i = 1.5$	$i = 1$	$i = 2$	$i = 1$	$i = 2$	$i = 2$		
Belt type		16 AT5	16 AT5	16 AT5	16 AT5	25 AT5	25 AT5	25 AT5	25 AT5	25 AT5		
Size	Ball screw $d_0 \times P$	L (mm)	M_{sd} (Nm)	M_{sd} (Nm)	J_{sd} (10^{-6} kgm ²)	J_{sd} (10^{-6} kgm ²)	L (mm)	M_{sd} (Nm)	M_{sd} (Nm)	J_{sd} (10^{-6} kgm ²)	J_{sd} (10^{-6} kgm ²)	
TKK 15-155	16 x 10	1180	9.6	6.4	260	91						
	16 x 16	1420	9.6	6.4								
	20 x 5	1420	9.6	6.4								
	20 x 20	2260	9.6	6.4								
TKK 20-225	20 x 5	1480	9.6	6.4	270	94	1480	10.0	5.0	1420	230	
	20 x 20	2200	9.6	6.4			1600	19.6	9.8			
	25 x 5	2320	9.6	6.4			1960	14.0	7.0			
	25 x 10	2860	9.6	6.4			2320	19.6	9.8			
	25 x 25	2860	9.6	6.4			2860	19.6	9.8			

Motor type		MSK 060C				MSK 076C						
Overall dimensions (mm)		66 x 116				90 x 160						
Frictional torque M_{Rsd} (Nm)		0.5				0.6						
Reduction $i = \dots$		Permissible torque up to length $L = \dots$ at ⁽¹⁾		Reduced mass moment of inertia at		Permissible torque up to length $L = \dots$ at ⁽¹⁾			Reduced mass moment of inertia at			
		$i = 1$	$i = 2$	$i = 1$	$i = 2$	$i = 1$	$i = 2$	$i = 1$	$i = 2$	$i = 2$		
Belt type		25 AT5	32 AT5	25 AT5	32 AT5	50 AT10	50 AT10	50 AT10	50 AT10	50 AT10		
Size	Ball screw $d_0 \times P$	L (mm)	M_{sd} (Nm)	M_{sd} (Nm)	J_{sd} (10^{-6} kgm ²)	J_{sd} (10^{-6} kgm ²)	L (mm)	M_{sd} (Nm)	M_{sd} (Nm)	J_{sd} (10^{-6} kgm ²)	J_{sd} (10^{-6} kgm ²)	
TKK 30-325	32 x 5	2860	19.0	9.5	1440	280						
	32 x 10	2860	19.0	13.0								
	32 x 20	2860	19.0	13.0								
	32 x 32	2860	19.0	13.0								
TKK 35-455	40 x 5						2860	26.0	13.0	7860	1280	
	40 x 10						2860	52.0	26.0			
	40 x 20						2860	67.0	33.5			
	40 x 40						2860	67.0	33.5			

1) Permissible torque for greater lengths available upon request.

- M_{sd} = maximum permissible torque at motor journal
 M_{Rsd} = frictional torque of timing belt side drive at motor journal
 J_{sd} = reduced mass moment of inertia of timing belt side drive
 i = timing belt side drive reduction
 d_0 = nominal diameter
 P = lead

Technical Data

Permissible travel speed

Ball Rail Table	Permissible travel speed v_{max} (m/s)
without drive without bellows	5
without drive with bellows	1.66
with drive with bellows	see charts

When selecting the motor, take account of the permissible travel speed of the Ball Rail Table or the selected ball screw drive.

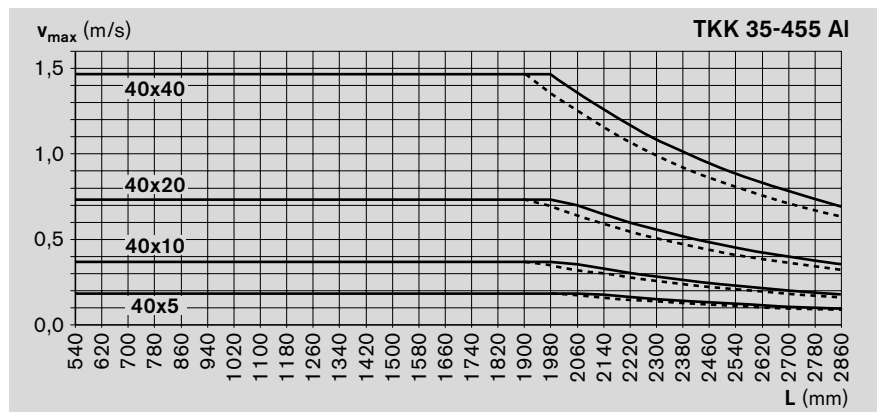
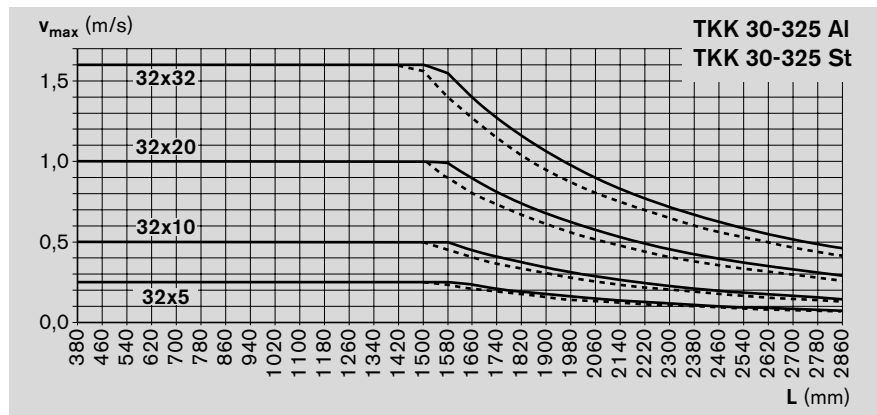
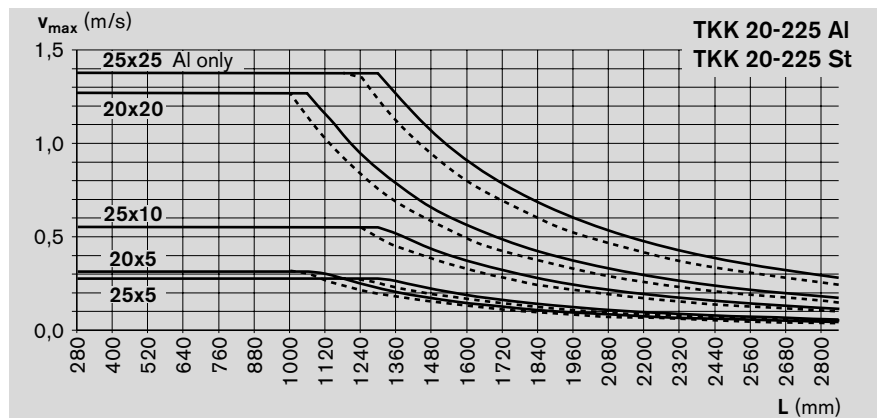
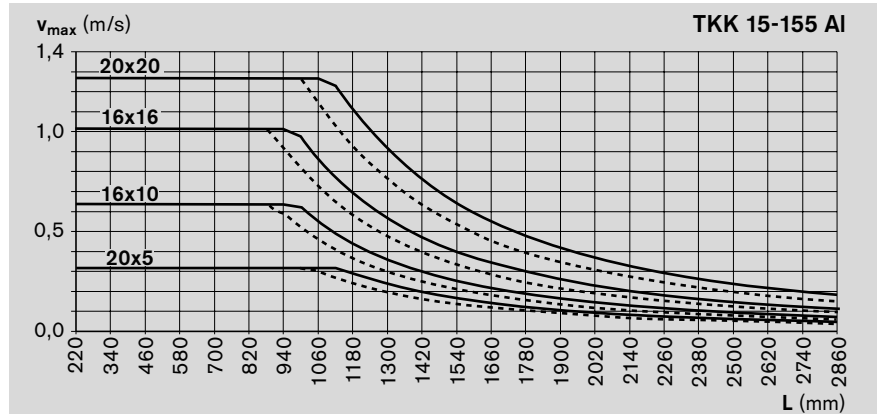

— with bellows
- - - without bellows

Maximum permissible drive torque, fixed bearing end (at the drive journal)

For motor attachment via motor mount and coupling at the fixed bearing end

For the permissible torque with a motor attached via timing belt drive, see "Timing belt side drive, floating bearing end."

The values shown for M_p apply under the following conditions:

- Horizontal operation
- Ball screw journal without keyway
- No radial load on ball screw shaft end
- Ball Rail Table with polyurethane bellows

Consider the rated torque of the coupling used!

Ball screw journal with keyway

For reasons of stress concentration and a reduction of the effective diameter, do not exceed the following maximum values for drive torque!

Size	M_p (Nm)
TKK 15-155	4.5
TKK 20-225	4.5 (BS $\varnothing 20$) 11.0 (BS $\varnothing 25$)
TKK 30-325	18.0
TKK 35-455	76.0

When comparing the chart and table, the lower of the two values will always apply!

Example:

TKK 15-155, ball screw 20x5, length 1060 mm

Drive torque $M_p \approx 3.9$ Nm from chart:

Maximum permissible drive torque as per table: 4.5 Nm

Drive torque for sizing: 3.9 Nm

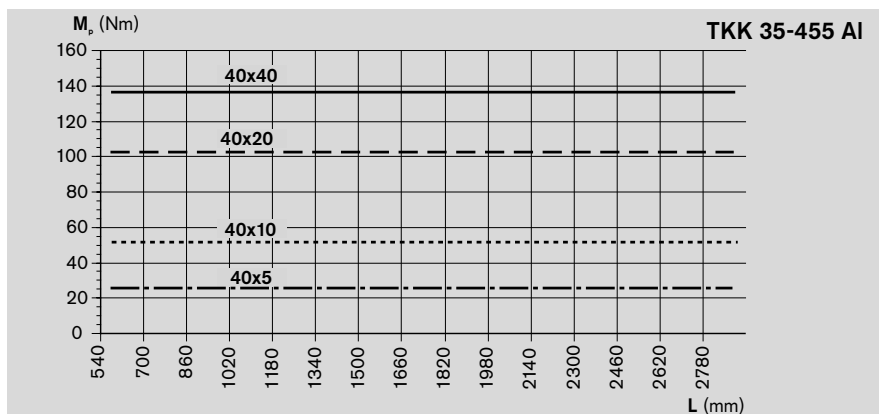
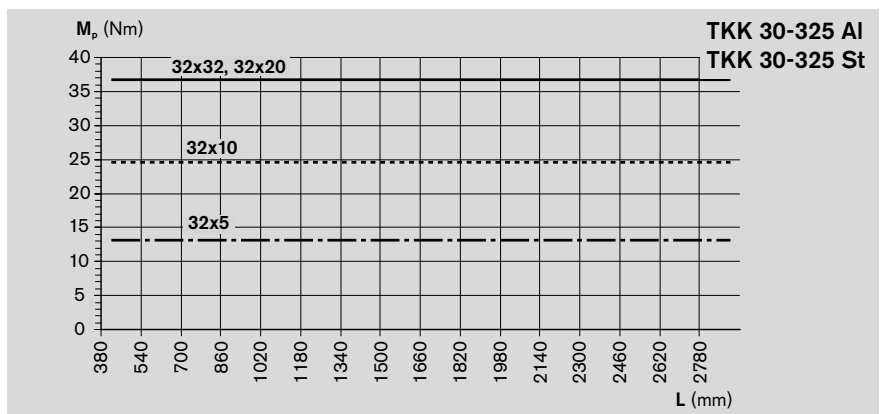
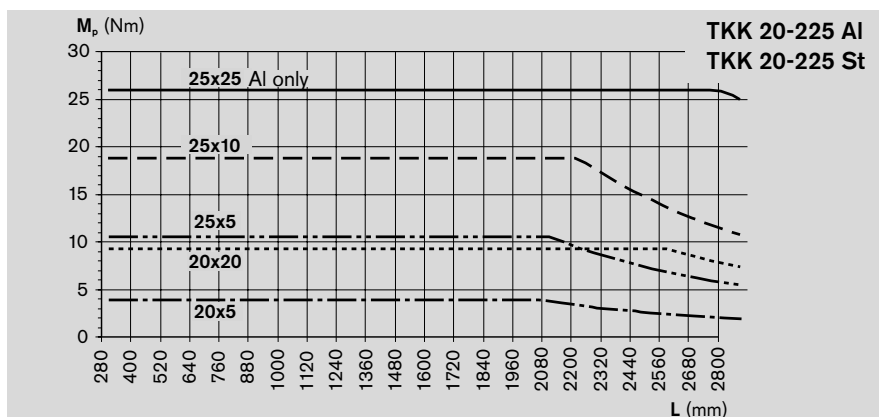
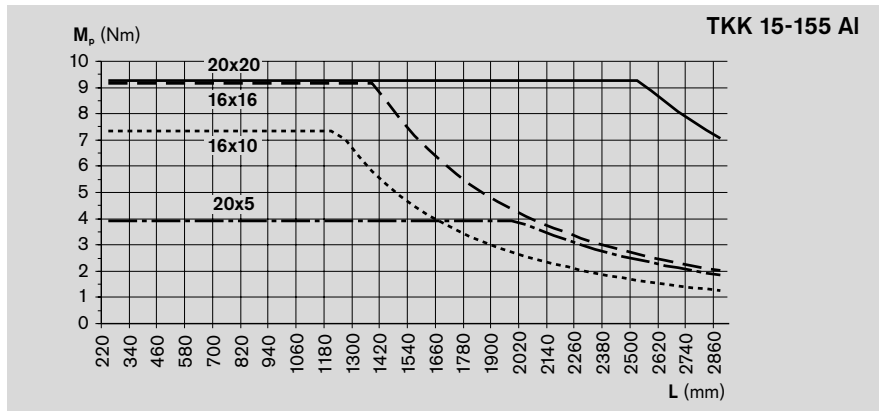

Calculations

Calculation principles

Combined equivalent load on bearing of the linear guide

$$F_{comb} = |F_y| + |F_z| + C \cdot \frac{|M_x|}{M_t} + C \cdot \frac{|M_y|}{M_L} + C \cdot \frac{|M_z|}{M_L}$$

The image shows a technical drawing of a ball rail table. On the left is a cross-section showing the internal ball bearings and the Z₁ dimension. On the right is a 3D perspective view showing the table with force vectors: F_y and F_z acting along the Y and Z axes, and moments M_x, M_y, M_z, M_t acting about the X, Y, Z, and table longitudinal axes respectively.

Size	Dimension (mm)
	Z ₁
TKK 15-155	23.7
TKK 20-225	36.6
TKK 30-325	48.5
TKK 35-455	65.5

- C = dynamic load capacity (N)
- F_{comb} = combined equivalent load on bearing (N)
- F_y = force in y-direction (N)
- F_z = force in z-direction (N)
- i = timing belt side drive reduction
- J_s = mass moment of inertia of linear motion system (without external load) (kgm²)
- k_{J fix} = constant for fixed-length portion of mass moment of inertia (10⁶ kgm²)
- k_{J var} = constant for variable-length portion of mass moment of inertia (10⁶ kgm²)
- L = nominal life in meters (m)
- L_h = nominal life in hours (h)
- M_L = dynamic longitudinal moment load capacity (Nm)
- M_R = frictional torque at motor journal (Nm)
- M_{Rs} = frictional torque of the system (Nm)
- M_{Rsd} = frictional torque of timing belt side drive at motor journal (Nm)
- M_t = dynamic torsional moment load capacity (Nm)
- M_x = torsional moment about the X-axis (Nm)
- M_y = torsional moment about the Y-axis (Nm)
- M_z = torsional moment about the Z-axis (Nm)
- v_m = average travel speed (m/s)
- Z₁ = application point of the effective force (mm)

Life expectancy

Nominal life of the guideway in meters:

$$L = \left(\frac{C}{F_{comb}} \right)^3 \cdot 10^5$$

Nominal life of the guideway in hours:

$$L_h = \frac{L}{3600 \cdot v_m}$$

Frictional torque

for motor attachment via motor mount and coupling:

$$M_R = M_{Rs}$$

for motor attachment via timing belt side drive:

$$M_R = \frac{M_{Rs}}{i} + M_{Rsd}$$

Mass moment of inertia of the linear motion system J_s referred to the drive journal

$$J_s = (k_{J fix} + k_{J var} \cdot L) \cdot 10^{-6}$$

Mass moment of inertia of the mechanical system referred to the motor journal

Motor attachment via motor mount and coupling:

$$J_{ex} = J_s + J_t + J_c$$

Motor attachment via timing belt side drive:

$$J_{ex} = \frac{J_s + J_t}{i^2} + J_{sd}$$

Translatory mass moment of inertia of external load referred to the drive journal

$$J_t = m_{ex} \cdot k_{jm} \cdot 10^{-6}$$

Mass moment of inertia of the drive train referred to the motor journal

$$J_{dc} = J_{ex} \cdot J_{br}$$

Mass moment of inertia ratio

$$V = \frac{J_{dc}}{J_m}$$

Application area	V
Handling	≤ 6.0
Processing	≤ 1.5

Total mass moment of inertia referred to the motor journal

$$J_{tot} = J_{dc} + J_m$$

Maximum permissible rotary speed for mechanical system

$$n_{mech} = \frac{v_{mech} \cdot i \cdot 1000 \cdot 60}{P}$$

$$n_{mech} < n_{m \max}$$

- J_{br} = mass moment of inertia, motor brake (kgm²)
- J_c = mass moment of inertia, coupling (kgm²)
- J_{dc} = mass moment of inertia, drive train (kgm²)
- J_{ex} = mass moment of inertia of mechanical system (kgm²)
- J_m = mass moment of inertia, motor (kgm²)
- J_s = mass moment of inertia of linear motion system (without external load) (kgm²)
- J_{sd} = mass moment of inertia of timing belt side drive at motor journal (kgm²)
- J_t = translatory mass moment of inertia of external load referred to the drive journal (kgm²)
- J_{tot} = total mass moment of inertia (kgm²)
- i = gear ratio of timing belt side drive (-)
- k_{jm} = constant for mass-specific portion of mass moment of inertia (10⁶ m²)
- m_{ex} = moved external load (kgm³)
- $n_{m \max}$ = maximum permissible rotary speed of motor with controller (min⁻¹)
- n_{mech} = maximum permissible rotary speed of mechanical system (min⁻¹)
- P = screw lead (mm)
- V = ratio of mass moments of inertia of drive train and motor (-)
- v_{mech} = maximum permissible linear speed of mechanical system (m/s)

Calculation example

When sizing the drive, the motor-controller combination must always be considered, as the motor type and performance data (e.g. maximum useful speed and maximum torque) will depend on the controller or control system used. (See also Product Overview, "Motor selection based on drive controllers and control system.")

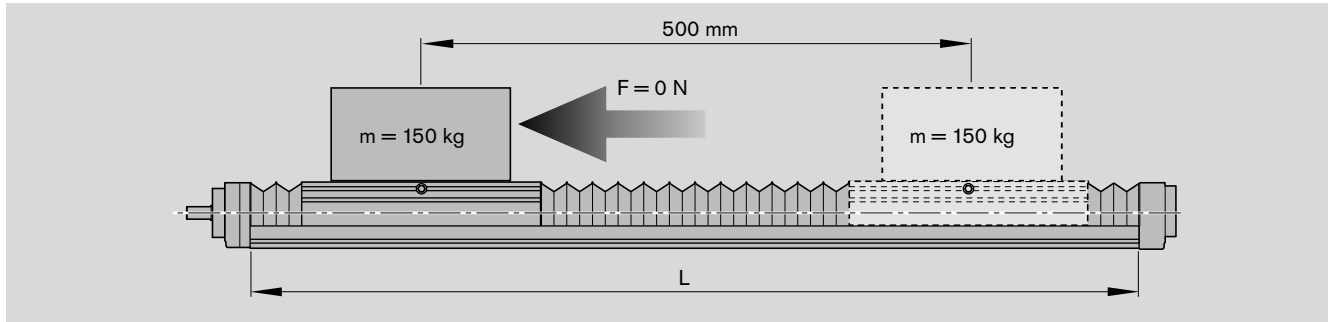

Given data

A mass of 150 kg is to be moved 500 mm at a maximum travel speed of 0.66 m/s. The following was selected based on the technical data and the connection dimensions:

Ball Rail Table TKK 30-325 AI

- $L_{ca} = 320$ mm
- 2% preload
- With protective bellows
- With motor MSK 060C attached via motor mount and coupling

Estimation of the Ball Rail Table length L

Excess travel	=	$2 \cdot P = 2 \cdot 32 \text{ mm} = 64 \text{ mm}$
Max. travel	=	$\text{stroke}_{\text{eff}} + 2 \cdot \text{excess travel}$
	=	$500 \text{ mm} + 2 \cdot 64 \text{ mm}$
	=	628 mm
Length L:		for max. travel = 628 mm
		from data sheet TKK 30-325 AI
L	=	1100 mm

Selection of ball screw

See charts in "Technical Data" section.

General recommendation:
Always select the lowest lead (resolution, braking distance, length).

Permissible ball screws according to the "Permissible travel speed" chart at $v = 0.66$ m/s and $L = 1100$ mm:

Ball screw 32 x 20 and ball screw 32 x 32

Ball screw selected (lower lead)

Ball screw 32 x 20

with a maximum permissible drive torque of 36.5 Nm as per "Permissible drive torque" chart for $L = 1100$ mm

Calculation of the Ball Rail Table length L

Excess travel	=	$2 \cdot P = 2 \cdot 20 \text{ mm} = 40 \text{ mm}$
Max. travel	=	$\text{stroke}_{\text{eff}} + 2 \cdot \text{excess travel}$
	=	$500 \text{ mm} + 2 \cdot 40 \text{ mm}$
	=	580 mm
L	=	1020 mm for max. travel = 580 mm
		(582 mm) from data sheet TKK 30-325 AI

Frictional torque M_R

M_R	=	M_{Rs} (see "Technical Data")
M_R	=	1.21 Nm

Mass moment of inertia of the mechanical system

$$\begin{aligned}
 J_{\text{ex}} &= J_{\text{S}} + J_{\text{t}} + J_{\text{C}} \\
 J_{\text{S}} &= (k_{\text{J fix}} + k_{\text{J var}} \cdot L) \cdot 10^{-6} \text{ kgm}^2 \\
 &= (265.3 + 0.667 \cdot 1020 \text{ mm}) \cdot 10^{-6} \text{ kgm}^2 \\
 &= 945.64 \cdot 10^{-6} \text{ kgm}^2 \quad (\text{see "Technical Data"}) \\
 J_{\text{t}} &= m_{\text{ex}} \cdot k_{\text{J m}} \cdot 10^{-6} \text{ kgm}^2 \\
 &= 150 \cdot 10.13 \cdot 10^{-6} \text{ kgm}^2 \\
 &= 1519.5 \cdot 10^{-6} \text{ kgm}^2 \quad (\text{see "Technical Data"}) \\
 J_{\text{C}} &= 200 \cdot 10^{-6} \text{ kgm}^2 \quad (\text{see "Technical Data"}) \\
 J_{\text{ex}} &= (945.64 + 1519.5 + 200) \cdot 10^{-6} \text{ kgm}^2 \\
 &= 2665 \cdot 10^{-6} \text{ kgm}^2 \\
 J_{\text{dc}} &= J_{\text{ex}} + J_{\text{br}} \\
 J_{\text{br}} &= 55 \cdot 10^{-6} \text{ kgm}^2 \quad (\text{see "Motors"}) \\
 J_{\text{dc}} &= (2665 + 55) \cdot 10^{-6} \text{ kgm}^2 \\
 &= 2720 \cdot 10^{-6} \text{ kgm}^2
 \end{aligned}$$

Mass moment of inertia for handling ($V \leq 6$)

$$\begin{aligned}
 V &= \frac{J_{\text{dc}}}{J_{\text{m}}} \leq 6 \\
 &= \frac{2720 \cdot 10^{-6} \text{ kgm}^2}{800 \cdot 10^{-6} \text{ kgm}^2} \\
 &= 3.4 \leq 6
 \end{aligned}$$

The selected motor (MSK 060C) is therefore suitable.

Rotary speed n at $v = 0.66 \text{ m/s}$

$$n_{\text{mech}} = \frac{v_{\text{mech}} \cdot i \cdot 1000 \cdot 60}{P} = \frac{0.66 \text{ m/s} \cdot 1 \cdot 1000 \cdot 60}{20 \text{ mm}} = 1980 \text{ min}^{-1}$$

$v_{\text{mech}} = 0.66 \text{ m/s}$ If the permissible travel speed of 0.66 m/s is not sufficient, switch to size 32 x 32 and repeat the calculation.

Result

Ball Rail Table	TKK 30-325 Al
Length	$L = 1020 \text{ mm}$
Ball screw:	
Diameter	32 mm;
Lead	20 mm;
Carriage length:	$L_{\text{ca}} = 320 \text{ mm};$
Preload:	2%

Motor attachment via motor mount and coupling

Motor with: – maximum useful speed $n_{\text{m max}} > 2000 \text{ min}^{-1}$
 – mass moment of inertia $J_{\text{m}} > 450 \cdot 10^{-6} \text{ kgm}^2$
 – maximum permissible drive torque $M_{\text{max}} < 36.5 \text{ Nm}$
 Consider the rated coupling torque M_{cN} and the frictional torque M_{R} ($M_{\text{cN}} = 50 \text{ Nm}; M_{\text{R}} = 1.21 \text{ Nm}$)

These requirements are fulfilled by all AC servo motors approved for TKK 30-325 Al in the "Components and Ordering Data" table.

The specific motor is selected:

- according to criteria in the "Motors" section
- and by recalculating the drive unit with performance data from the "ECODRIVE Cs" and "IndraDrive for Linear Motion Systems" catalogs.



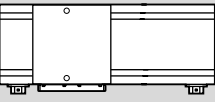
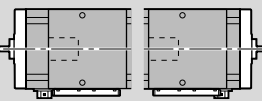
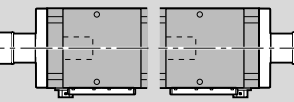
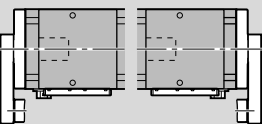
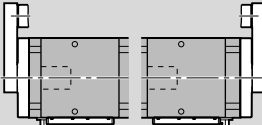
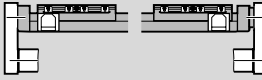

TKK 15-155 AI Components and Ordering

Part number, length R1460 205 00, ... mm	Dimension drawing	Guideway	Drive unit				Carriage				
			Ball screw journal keyway	Ball screw			150 mm Preload		220 mm Preload		
Reference edge		Base plate, low		16 x 10	16 x 16	20 x 5	20 x 20	2%	8%	2%	8%
Without drive (without end-plates)											
OA01 	OA01	01		00				01	02	03	04
Without motor mount and motor											
OF01  OF04	OF01 OF04	01	ø10 (fixed bearing end)	01	07	13	19	01	02	03	04
			ø10 (fixed bearing end) ¹⁾	04	10	16	22				
With motor mount and coupling, with or without motor											
MF01  MF02	MF01 MF02	01	ø10 (fixed bearing end)	01	07	13	19	01	02	03	04
With timing belt side drive, with or without motor											
RV01  RV02	RV01-RV04	01	ø11 (floating bearing end)	03	09			01	02	03	04
RV03  RV04											
RV05  RV06	RV05 RV06		ø14 (floating bearing end)			15	21	01	02	03	04

1) With keyway

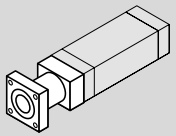
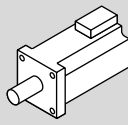
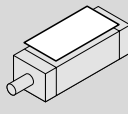
Please check whether the selected combination is a permissible one (load capacities, moments, maximum speeds, motor data, etc.)!

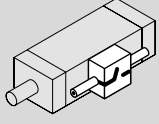
For more information on ordering, see order example.

i	Motor attachment ²⁾ Mounting orientation		Motor		Cover PU bellows		Position meas- uring system		Switches (1st, 2nd, 3rd), switching cam, socket, plug, cable duct		Documentation	
												
			without	00	without	with	with- out	Glass scale			Standard report	Special report
	OA01	00	without	00	00	on re- quest						
	OF01-OF04	00	without	00								02 Friction moment
1	MF01-MF02	02	MSK 040C	86 ³⁾	00	01	00	on re- quest			01	03 Lead deviation
				87 ⁴⁾								
		06	MSM 040B	74 ³⁾								
				75 ⁴⁾								
		04	VRDM 397	37 ³⁾								
		04	VRDM 3910	39 ³⁾								
					40 ⁴⁾							
		05	VRDM 3913	41 ³⁾								
					42 ⁴⁾							
1	RV01-RV04	41	MSK 040C	86 ³⁾	00	01	00	on re- quest			01	04 Travel accuracy
		RV05-RV06		42								
1.5	RV01-RV04	43	MSK 040C	87 ⁴⁾	00	01	00	on re- quest			01	04 Travel accuracy
		RV05-RV06		44								
1	RV01-RV04	53	MSM 040B	74 ³⁾	00	01	00	on re- quest			01	04 Travel accuracy
		RV05-RV06		54								
1.5	RV01-RV04	55	MSM 040B	75 ⁴⁾	00	01	00	on re- quest			01	04 Travel accuracy
		RV05-RV06		56								
1	RV01-RV04	45	MSK 040C	86 ³⁾	00	01	00	on re- quest			01	05 Positioning accuracy
		RV05-RV06		46								
1.5	RV01-RV04	47	MSK 040C	87 ⁴⁾	00	01	00	on re- quest			01	05 Positioning accuracy
		RV05-RV06		48								
1	RV01-RV04	49	MSM 040B	74 ³⁾	00	01	00	on re- quest			01	05 Positioning accuracy
		RV05-RV06		50								
1.5	RV01-RV04	51	MSM 040B	75 ⁴⁾	00	01	00	on re- quest			01	05 Positioning accuracy
		RV05-RV06		52								

2) Attachment kit also available without motor (when ordering enter "00" for motor)
 3) Without brake
 4) With brake

..... Optional

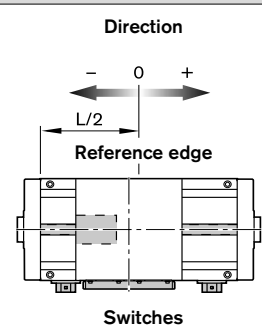

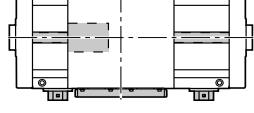
Without switches		
without switch	00	
without cable duct		
With switches		
<p>Direction</p> <p>- 0 +</p> <p>← →</p> <p>L/2</p> <p>Reference edge</p>  <p>Switches</p>		
External switches		
PNP NC	Switch- ing cam, external	External socket/ plug (loose)
11-A +/-... mm		
PNP NO		
13-A +/-... mm		
Mechanical	16	17
15-A +/-... mm		
Cable duct (loose)		
Cable duct	20 - X....	

TKK 15-155 Al – Dimensions

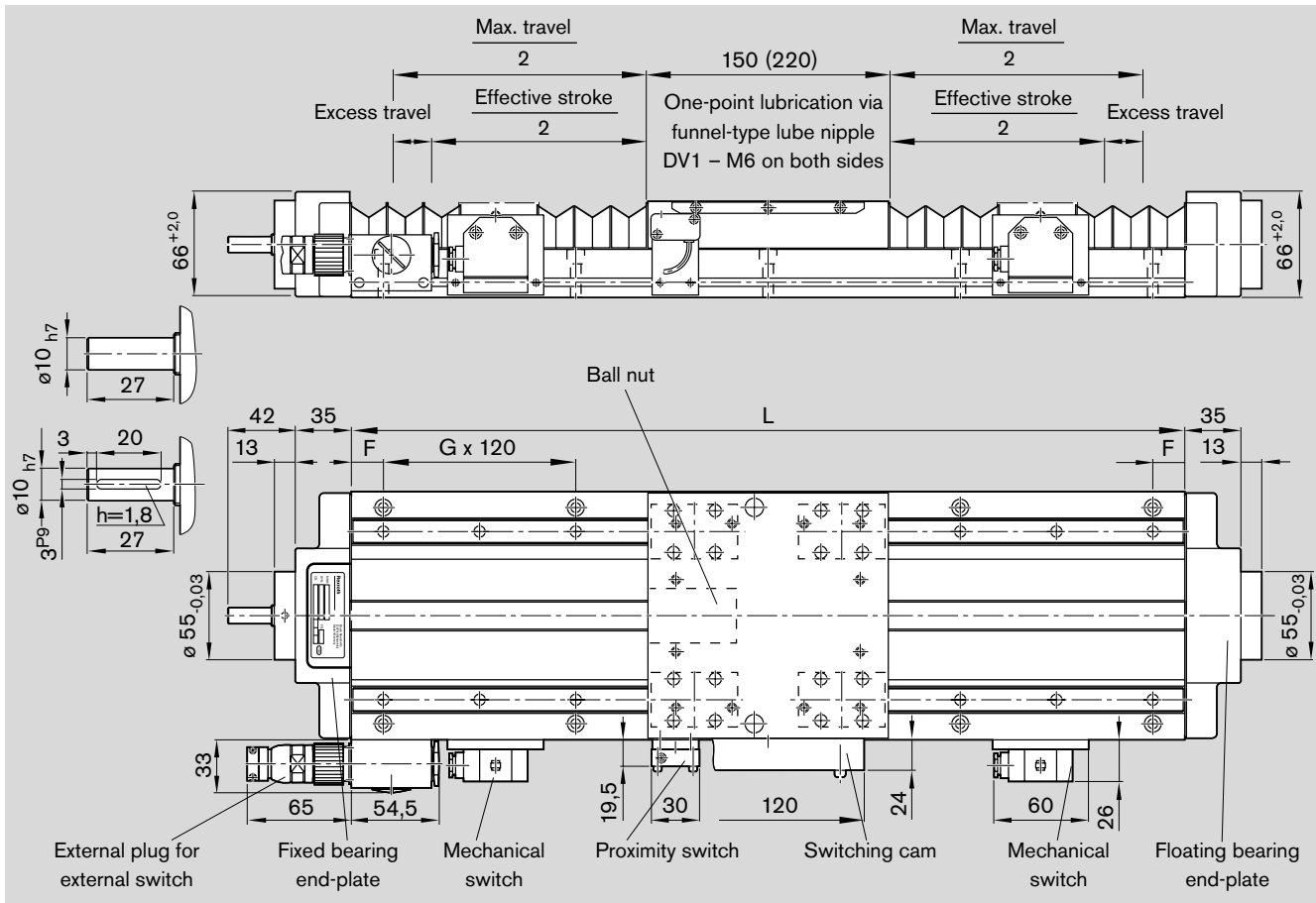

Length L (mm)	Counterbored mounting hole spacing F - G x 120 - F	Max. travel (mm) for carriage length with bellows			
		150	220	150	220
220	50 - 1 x 120 - 50	-	-	60	-
280	20 - 2 x 120 - 20	68	-	120	-
340	50 - 2 x 120 - 50	117	59	180	110
400	20 - 3 x 120 - 20	166	109	240	170
460	50 - 3 x 120 - 50	216	158	300	230
520	20 - 4 x 120 - 20	265	207	360	290
580	50 - 4 x 120 - 50	315	257	420	350
640	20 - 5 x 120 - 20	364	306	480	410
700	50 - 5 x 120 - 50	414	356	540	470
760	20 - 6 x 120 - 20	463	405	600	530
820	50 - 6 x 120 - 50	512	454	660	590
880	20 - 7 x 120 - 20	562	504	720	650
940	50 - 7 x 120 - 50	611	553	780	710
1000	20 - 8 x 120 - 20	661	603	840	770
1060	50 - 8 x 120 - 50	710	652	900	830
1120	20 - 9 x 120 - 20	759	702	960	890
1180	50 - 9 x 120 - 50	809	751	1020	950
1240	20 - 10 x 120 - 20	858	800	1080	1010
1300	50 - 10 x 120 - 50	908	850	1140	1070
1360	20 - 11 x 120 - 20	957	899	1200	1130
1420	50 - 11 x 120 - 50	1007	949	1260	1190
1480	20 - 12 x 120 - 20	1056	998	1320	1250
1540	50 - 12 x 120 - 50	1105	1048	1380	1310

Length L (mm)	Counterbored mounting hole spacing F - G x 120 - F	Max. travel (mm) for carriage length			
		with bellows	150	220	without bellows
1600	20 - 13 x 120 - 20	1155	1097	1440	1370
1660	50 - 13 x 120 - 50	1204	1146	1500	1430
1720	20 - 14 x 120 - 20	1254	1196	1560	1490
1780	50 - 14 x 120 - 50	1303	1245	1620	1550
1840	20 - 15 x 120 - 20	1353	1295	1680	1610
1900	50 - 15 x 120 - 50	1402	1344	1740	1670
1960	20 - 16 x 120 - 20	1451	1394	1800	1730
2020	50 - 16 x 120 - 50	1501	1443	1860	1790
2080	20 - 17 x 120 - 20	1550	1492	1920	1850
2140	50 - 17 x 120 - 50	1600	1542	1980	1910
2200	20 - 18 x 120 - 20	1649	1591	2040	1970
2260	50 - 18 x 120 - 50	1699	1641	2100	2030
2320	20 - 19 x 120 - 20	1748	1690	2160	2090
2380	50 - 19 x 120 - 50	1797	1739	2220	2150
2440	20 - 20 x 120 - 20	1847	1789	2280	2210
2500	50 - 20 x 120 - 50	1896	1838	2340	2270
2560	20 - 21 x 120 - 20	1946	1888	2400	2330
2620	50 - 21 x 120 - 50	1995	1937	2460	2390
2680	20 - 22 x 120 - 20	2045	1987	2520	2450
2740	50 - 22 x 120 - 50	2094	2036	2580	2510
2800	20 - 23 x 120 - 20	2143	2085	2640	2570
2860	50 - 23 x 120 - 50	2193	2135	2700	2630

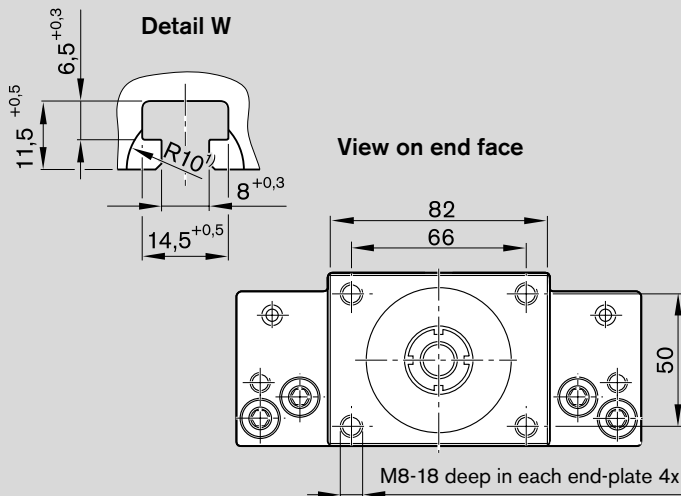
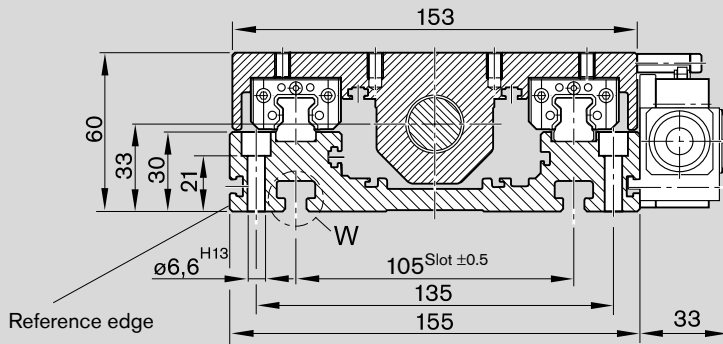

Mounting hole pattern for carriage length $L_{ca} = 150$

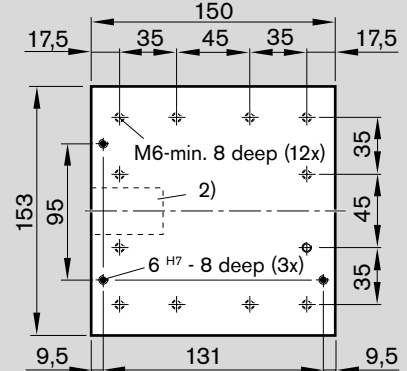

Mounting hole pattern for carriage length $L_{ca} = 220$

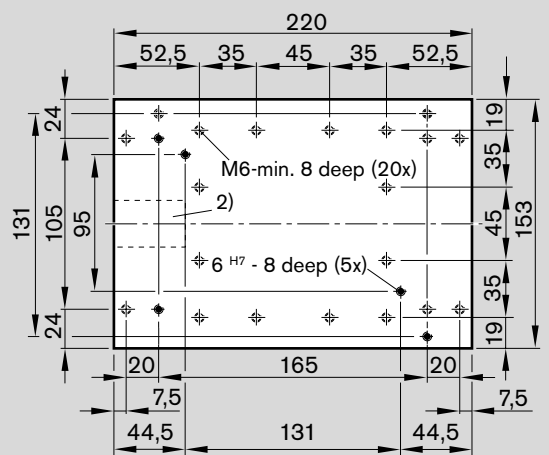

- 1) Min. 25 deep (4x)
- 2) Ball nut

Effective stroke

For safe operation, the excess travel must be longer than the braking distance. The acceleration travel can be taken as a guideline value for the braking distance. In most cases, 2x the ball screw lead (P) will be sufficient. Example for P = 5 mm: Excess travel (braking distance) ≈ 10 mm

Recommended standard configuration:

- 2 mechanical switches
- 1 proximity switch

$$\text{Effective stroke} = \text{max. travel} - 2 \cdot \text{excess travel}$$

Distance between switch activation points of two switches

Switch position	For switch combination	Min. spacing (mm)
external	mechanical – mechanical	60.0
	mechanical – proximity	45.0
	proximity – proximity	12.5

Maximum switch activation point

The switch activation point characterizes the position of the center of the carriage after travel. The zero point is at L/2.

$$\text{Maximum switch activation point} = 0.5 \cdot \text{max. travel} - \text{excess travel}$$

TKK 15-155 Al – Dimension Drawings, Motor Attachment

Motor attachment with motor mount and coupling

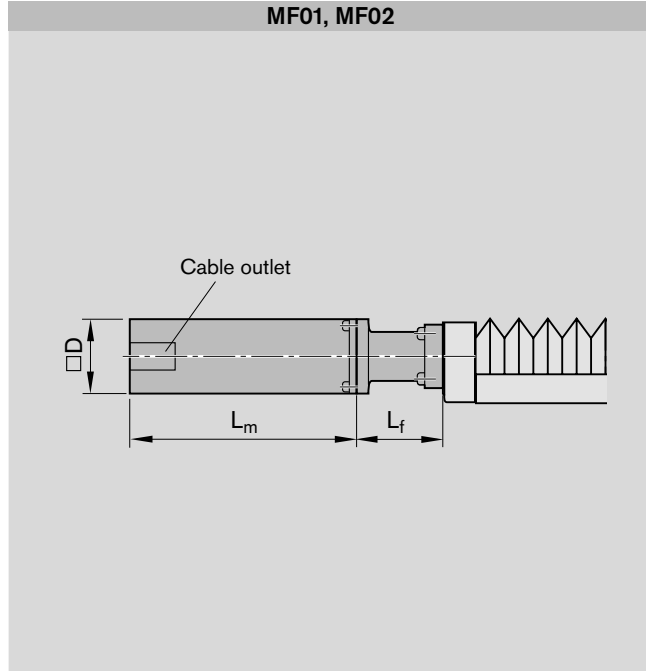

Motor	Dimensions (mm)		
	L_m	D	L_f
MSK 040C	185.5 ¹⁾	82	90
	215.5 ²⁾		
MSM 040B	157.5 ¹⁾	80	90
	191.5 ²⁾		
VRDM 397	110.0 ¹⁾	85	90
	156.5 ²⁾		
VRDM 3910	140.0 ¹⁾		
	186.5 ²⁾		
VRDM 3913	170.0 ¹⁾		
	216.5 ²⁾		

1) Without brake

2) With brake

Motor attachment via timing belt side drive

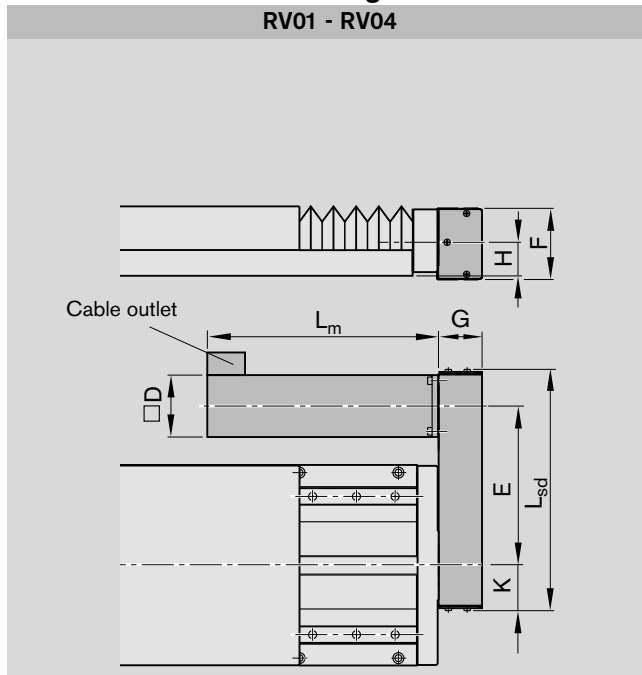

Motor	Dimensions (mm)									
	L _m	D	G	H	L _{sd}	i=1	i=1.5	E	K	F
MSK 040C	185.5 ¹⁾ 215.5 ²⁾	82	51	33	272	157.5	162.0	47.5	88	
MSM 040B	157.5 ¹⁾ 191.5 ²⁾									

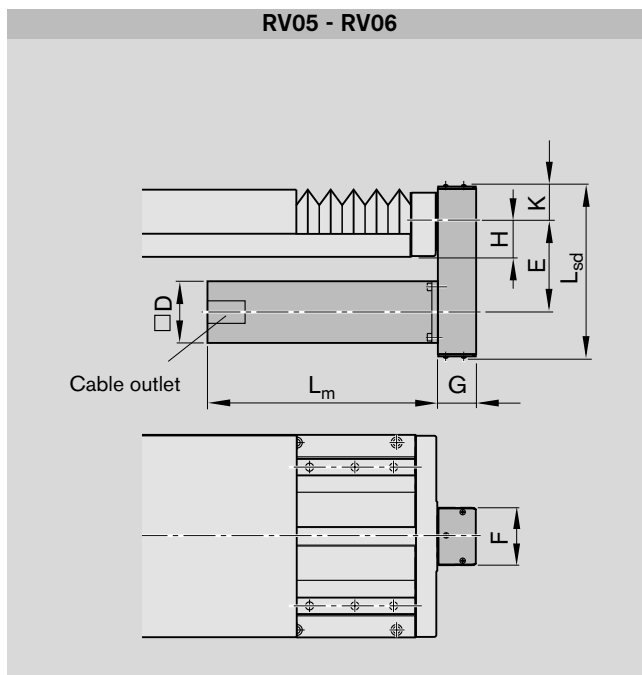

Motor	Dimensions (mm)									
	L _m	D	G	H	L _{sd}	i=1	i=1.5	E	K	F
MSK 040C	185.5 ²⁾ 215.5 ²⁾	82	51	33	231	122.5	122.0	47.5	88	
MSM 040B	157.5 ¹⁾ 191.5 ²⁾									

- 1) Without brake
- 2) With brake

Note for multi-axis units

(e.g. X-Y tables)

For multi-axis units with motor attachment via timing belt side drive, the motor may project into the working area of adjacent axes. Check for any interference contours.



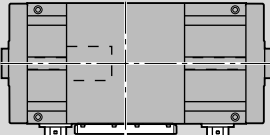
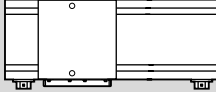
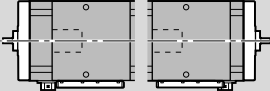
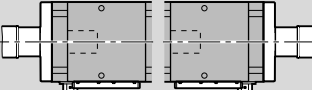
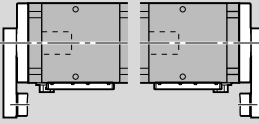
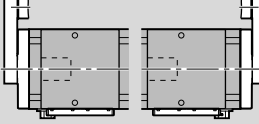
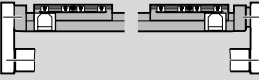

For motor dimensions, see "Motors."

TKK 20-225 AI Components and Ordering

Part number, length R1460 305 00, ... mm Reference edge  Switches	Dimension drawing	Guideway		Drive unit					Carriage				
		low	high	Ball screw journal keyway	20 x 5	20 x 20	25 x 5	25 x 10	25 x 25	220 mm Preload		320 mm Preload	
Without drive (without end-plates) OA01 	OA01	01	11		00					01	02	03	04
Without motor mount and motor OF01  OF04	OF01 OF04	01	11	ø10 (fixed bearing end)	01	07				01	02	03	04
				ø10 (fixed bearing end) ¹⁾	04	10							
				ø14 (fixed bearing end)			13	19					
				ø14 (fixed bearing end) ¹⁾			16	22					
				ø14 (fixed bearing end)					25	05	06	07	08
				ø14 (fixed bearing end) ¹⁾					28				
With motor mount and coupling, with or without motor MF01  MF02	MF01 MF02	01	11	ø10 (fixed bearing end)	01	07				01	02	03	04
				ø14 (fixed bearing end)			13	19		01	02	03	04
									25	05	06	07	08
With timing belt side drive, with or w/o motor RV01  RV02 RV03  RV04 RV05  RV06	RV01- RV04 RV05 RV06	01	11	ø14 (floating bearing end)	03	09	15	21		01	02	03	04
									27	05	06	07	08

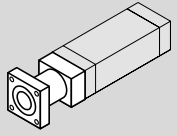
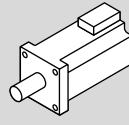
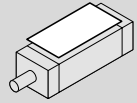
1) With keyway

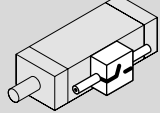
Please check whether the selected combination is a permissible one (load capacities, moments, maximum speeds, motor data, etc.)!
For more information on ordering, see order example.

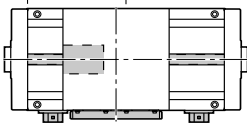
Motor attachment ²⁾ Mounting orientation		Motor		Cover PU bellows		Position meas- uring system		Switches (1st, 2nd, 3rd), switching cam, socket, plug, cable duct		Documentation																																									
																																																			
i				with- out with		with- out Glass scale				Standard report Special report																																									
	OA01	00	without	00	00	on request					02 Friction moment																																								
	OF01-OF04	00	without	00																																															
1	MF01-MF02	02	MSK 040C	86 ³⁾ 87 ⁴⁾	00	01	00	on request	<p>Without switches</p> <table border="1"> <tr> <td>without switch</td> <td rowspan="2">00</td> </tr> <tr> <td>without cable duct</td> </tr> </table> <p>With switches</p> <p>Direction</p>  <p>Reference edge</p>  <p>Switches</p> <table border="1"> <tr> <td colspan="3">Internal switches</td> </tr> <tr> <td>PNP NC</td> <td rowspan="4">Socket/plug on end-plate, switching cam</td> <td rowspan="4">07</td> </tr> <tr> <td>01-l +/-... mm</td> </tr> <tr> <td>PNP NO</td> </tr> <tr> <td>03-l +/-... mm</td> </tr> <tr> <td>Mechanical</td> <td></td> <td></td> </tr> <tr> <td>05-l +/-... mm</td> <td></td> <td></td> </tr> <tr> <td colspan="3">External switches</td> </tr> <tr> <td>PNP NC</td> <td rowspan="3">Switch- ing cam, external</td> <td rowspan="3">16</td> </tr> <tr> <td>11-A +/-... mm</td> </tr> <tr> <td>PNP NO</td> </tr> <tr> <td>13-A +/-... mm</td> <td rowspan="2">External socket/ plug (loose)</td> <td rowspan="2">17</td> </tr> <tr> <td>Mechanical</td> </tr> <tr> <td>15-A +/-... mm</td> <td></td> <td></td> </tr> <tr> <td colspan="3">Cable duct (loose)</td> </tr> <tr> <td colspan="2">Cable duct</td> <td colspan="2">20 - X...</td> </tr> </table>	without switch	00	without cable duct	Internal switches			PNP NC	Socket/plug on end-plate, switching cam	07	01-l +/-... mm	PNP NO	03-l +/-... mm	Mechanical			05-l +/-... mm			External switches			PNP NC	Switch- ing cam, external	16	11-A +/-... mm	PNP NO	13-A +/-... mm	External socket/ plug (loose)	17	Mechanical	15-A +/-... mm			Cable duct (loose)			Cable duct		20 - X...		01	03 Lead deviation
		without switch	00																																																
		without cable duct																																																	
		Internal switches																																																	
		PNP NC	Socket/plug on end-plate, switching cam	07																																															
		01-l +/-... mm																																																	
PNP NO																																																			
03-l +/-... mm																																																			
Mechanical																																																			
05-l +/-... mm																																																			
External switches																																																			
PNP NC	Switch- ing cam, external	16																																																	
11-A +/-... mm																																																			
PNP NO																																																			
13-A +/-... mm	External socket/ plug (loose)	17																																																	
Mechanical																																																			
15-A +/-... mm																																																			
Cable duct (loose)																																																			
Cable duct		20 - X...																																																	
1	MF01-MF02	04	MSK 040C	86 ³⁾ 87 ⁴⁾	00	01	00	on request			04 Travel accuracy																																								
		11	MSM 040B	74 ³⁾ 75 ⁴⁾																																															
		13	MSK 050C	88 ³⁾ 89 ⁴⁾																																															
1	RV01-RV04	45	MSK 040C	86 ³⁾							05 Positioning accuracy																																								
		46		87 ⁴⁾																																															
1.5	RV01-RV04	47	MSK 040C	86 ³⁾																																															
		48		87 ⁴⁾																																															
1	RV01-RV04	49	MSM 040B	74 ³⁾																																															
		50		75 ⁴⁾																																															
1.5	RV01-RV04	51	MSM 040B	74 ³⁾																																															
		52		75 ⁴⁾																																															
1	RV01-RV04	53	MSK 050C	88 ³⁾																																															
		55		89 ⁴⁾																																															
2	RV01-RV04	54	MSK 050C	88 ³⁾																																															
		56		89 ⁴⁾																																															

----- Optional

2) Attachment kit also available without motor
(when ordering enter "00" for motor)

3) Without brake

4) With brake

TKK 20-225 AI – Dimensions

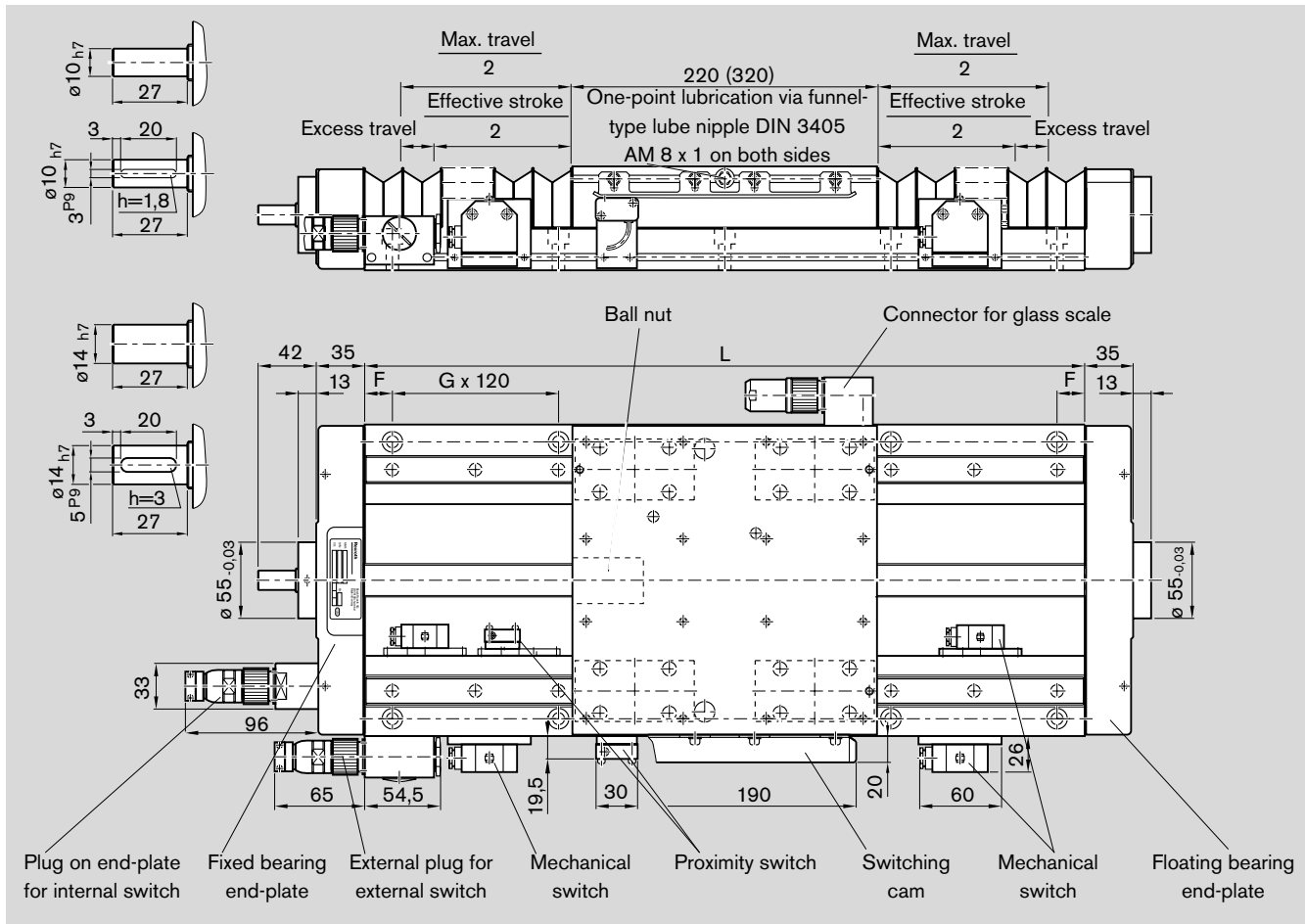

Length L (mm)	Counterbored mounting hole spacing F - G x 120 - F	Max. travel (mm) for carriage length			
		with bellows		without bellows	
340	50 - 2 x 120 - 50	70	-	110	-
400	20 - 3 x 120 - 20	122	-	170	-
460	50 - 3 x 120 - 50	174	86	230	130
520	20 - 4 x 120 - 20	226	138	290	190
580	50 - 4 x 120 - 50	278	190	350	250
640	20 - 5 x 120 - 20	330	242	410	310
700	50 - 5 x 120 - 50	382	294	470	370
760	20 - 6 x 120 - 20	434	346	530	430
820	50 - 6 x 120 - 50	486	398	590	490
880	20 - 7 x 120 - 20	538	450	650	550
940	50 - 7 x 120 - 50	590	502	710	610
1000	20 - 8 x 120 - 20	642	554	770	670
1060	50 - 8 x 120 - 50	694	606	830	730
1120	20 - 9 x 120 - 20	746	658	890	790
1180	50 - 9 x 120 - 50	798	710	950	850
1240	20 - 10 x 120 - 20	850	762	1010	910
1300	50 - 10 x 120 - 50	902	814	1070	970
1360	20 - 11 x 120 - 20	954	866	1130	1030
1420	50 - 11 x 120 - 50	1006	918	1190	1090
1480	20 - 12 x 120 - 20	1058	970	1250	1150
1540	50 - 12 x 120 - 50	1110	1022	1310	1210
1600	20 - 13 x 120 - 20	1162	1074	1370	1270

Length L (mm)	Counterbored mounting hole spacing F - G x 120 - F	Max. travel (mm) for carriage length			
		with bellows		without bellows	
1660	50 - 13 x 120 - 50	1214	1126	1430	1330
1720	20 - 14 x 120 - 20	1266	1178	1490	1390
1780	50 - 14 x 120 - 50	1318	1230	1550	1450
1840	20 - 15 x 120 - 20	1370	1282	1610	1510
1900	50 - 15 x 120 - 50	1422	1334	1670	1570
1960	20 - 16 x 120 - 20	1474	1386	1730	1630
2020	50 - 16 x 120 - 50	1526	1438	1790	1690
2080	20 - 17 x 120 - 20	1578	1490	1850	1750
2140	50 - 17 x 120 - 50	1630	1542	1910	1810
2200	20 - 18 x 120 - 20	1682	1594	1970	1870
2260	50 - 18 x 120 - 50	1734	1646	2030	1930
2320	20 - 19 x 120 - 20	1786	1698	2090	1990
2380	50 - 19 x 120 - 50	1838	1750	2150	2050
2440	20 - 20 x 120 - 20	1890	1802	2210	2110
2500	50 - 20 x 120 - 50	1942	1854	2270	2170
2560	20 - 21 x 120 - 20	1994	1906	2330	2230
2620	50 - 21 x 120 - 50	2046	1958	2390	2290
2680	20 - 22 x 120 - 20	2098	2010	2450	2350
2740	50 - 22 x 120 - 50	2150	2062	2510	2410
2800	20 - 23 x 120 - 20	2202	2114	2570	2470
2860	50 - 23 x 120 - 50	2254	2166	2630	2530

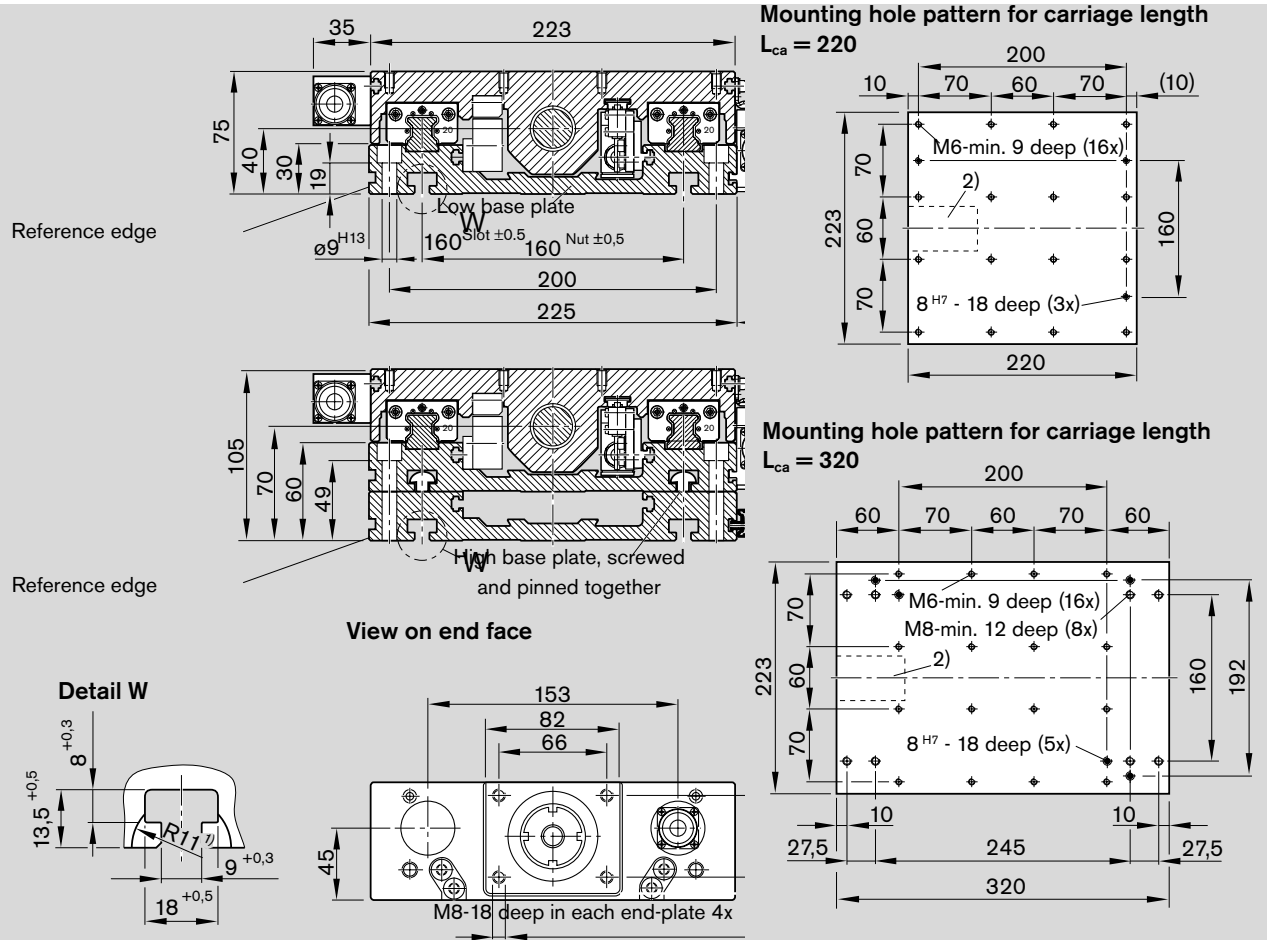

- 1) 27 deep (4x)
- 2) Ball nut

Effective stroke

For safe operation, the excess travel must be longer than the braking distance. The acceleration travel can be taken as a guideline value for the braking distance. In most cases, 2x the ball screw lead (P) will be sufficient. Example for P = 5 mm:

Excess travel (braking distance) ≈ 10 mm

Recommended standard configuration:

- 2 mechanical switches
- 1 proximity switch

$$\text{Effective stroke} = \text{max. travel} - 2 \cdot \text{excess travel}$$

Distance between switch activation points of two switches

Switch position	For switch combination	Min. spacing (mm)
external	mechanical – mechanical	60.0
	mechanical – proximity	45.0
	proximity – proximity	12.5
internal	mechanical – mechanical	70.0
	mechanical – proximity	50.0
	proximity – proximity	25.0

Maximum switch activation point

The switch activation point characterizes the position of the center of the carriage after travel. The zero point is at L/2.

$$\text{Maximum switch activation point} = 0.5 \cdot \text{max. travel} - \text{excess travel}$$



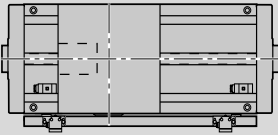
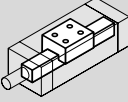
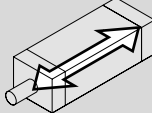
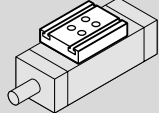
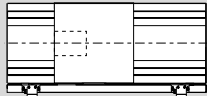
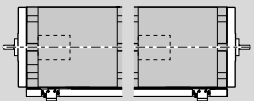
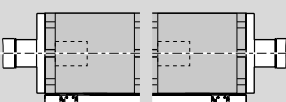
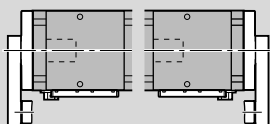
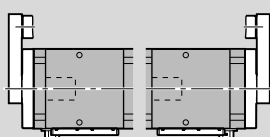
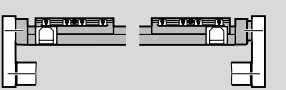

TKK 20-225 St Components and Ordering

Part number, length R1460 300 00, ... mm Reference edge  Switches	Dimension drawing	Guideway  Base plate, low	Drive unit  Ball screw journal keyway				Carriage  Carriage length L_{ca} 220 mm Preload 2% 8% 320 mm Preload 2% 8%				
Without drive (without end-plates)				Ball screw 20 x 5 20 x 20 25 x 5 25 x 10							
OA01 	OA01	01	00				01	02	03	04	
Without motor mount and motor OF01 OF04 	OF01 OF04	01	$\varnothing 10$ (fixed bearing end) $\varnothing 10$ (fixed bearing end) ¹⁾ $\varnothing 14$ (fixed bearing end) $\varnothing 14$ (fixed bearing end) ¹⁾	01 04	07 10			01	02	03	04
With motor mount and coupling, with or without motor MF01 MF02 	MF01 MF02	01	$\varnothing 10$ (fixed bearing end) $\varnothing 14$ (fixed bearing end)	01	07			01	02	03	04
With timing belt side drive, with or w/o motor RV01 RV02  RV03 RV04  RV05 RV06 	RV01- RV04 RV05 RV06	01	$\varnothing 14$ (floating bearing end)	03	09	15	21	01	02	03	04

1) With keyway

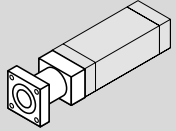
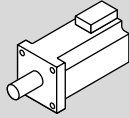
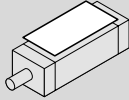
Please check whether the selected combination is a permissible one (load capacities, moments, maximum speeds, motor data, etc.)!

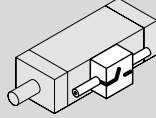
For more information on ordering, see order example.

Motor attachment ²⁾ Mounting orientation		Motor		Cover PU bellows		Position meas- uring system		Switches (1st, 2nd, 3rd), switching cam, socket, plug, cable duct		Documentation	
											
i				with- out with		with- out Glass scale				Standard report Special report	
	OA01	00	without	00	00	on request					02 Friction moment
	OF01 OF04	00	without	00							
1	MF01 MF02	02	MSK 040C	86 ³⁾ 87 ⁴⁾							03 Lead deviation
		08	VRDM 397	37 ³⁾ 38 ⁴⁾							
			VRDM 3910	39 ³⁾ 40 ⁴⁾							
		09	VRDM 3913	41 ³⁾ 42 ⁴⁾							
		10	MSM 040B	74 ³⁾ 75 ⁴⁾							
		12	MSK 050C	88 ³⁾ 89 ⁴⁾							
					00	01	00	on request			04 Travel accuracy
1	MF01 MF02	04	MSK 040C	86 ³⁾ 87 ⁴⁾							
		11	MSM 040B	74 ³⁾ 75 ⁴⁾							
		13	MSK 050C	88 ³⁾ 89 ⁴⁾							
1.5	RV01-RV04	47	MSK 040C	86 ³⁾							
	RV05-RV06	48		87 ⁴⁾							
1	RV01-RV04	49	MSM 040B	74 ³⁾							
	RV05-RV06	50									
1.5	RV01-RV04	51	MSM 040B	75 ⁴⁾							
	RV05-RV06	52									
1	RV01-RV04	53	MSK 050C	88 ³⁾							05 Positioning accuracy
	RV05-RV06	55									
2	RV01-RV04	54	MSK 050C	89 ⁴⁾							
	RV05-RV06	56									

2) Attachment kit also available without motor (when ordering enter "00" for motor)

----- Optional

3) Without brake

4) With brake

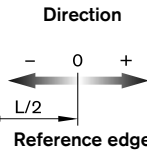
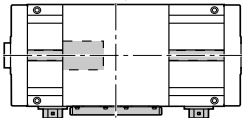
Without switches		
without switch	00	
without cable duct		
With switches		
<p>Direction</p>  <p>Reference edge</p>  <p>Switches</p>		
Internal switches		
PNP NC	Socket/plug on end-plate, switching cam 07	
01-l +/-... mm		
PNP NO		
03-l +/-... mm		
Mechanical		
05-l +/-... mm		
External switches		
PNP NC	Switch- ing cam, external 26	External socket/ plug (loose) 17
11-A +/-... mm		
PNP NO		
13-A +/-... mm		
Mechanical		
15-A +/-... mm		
Cable duct (loose)		
Cable duct	20 - X....	

TKK 20-225 St – Dimensions

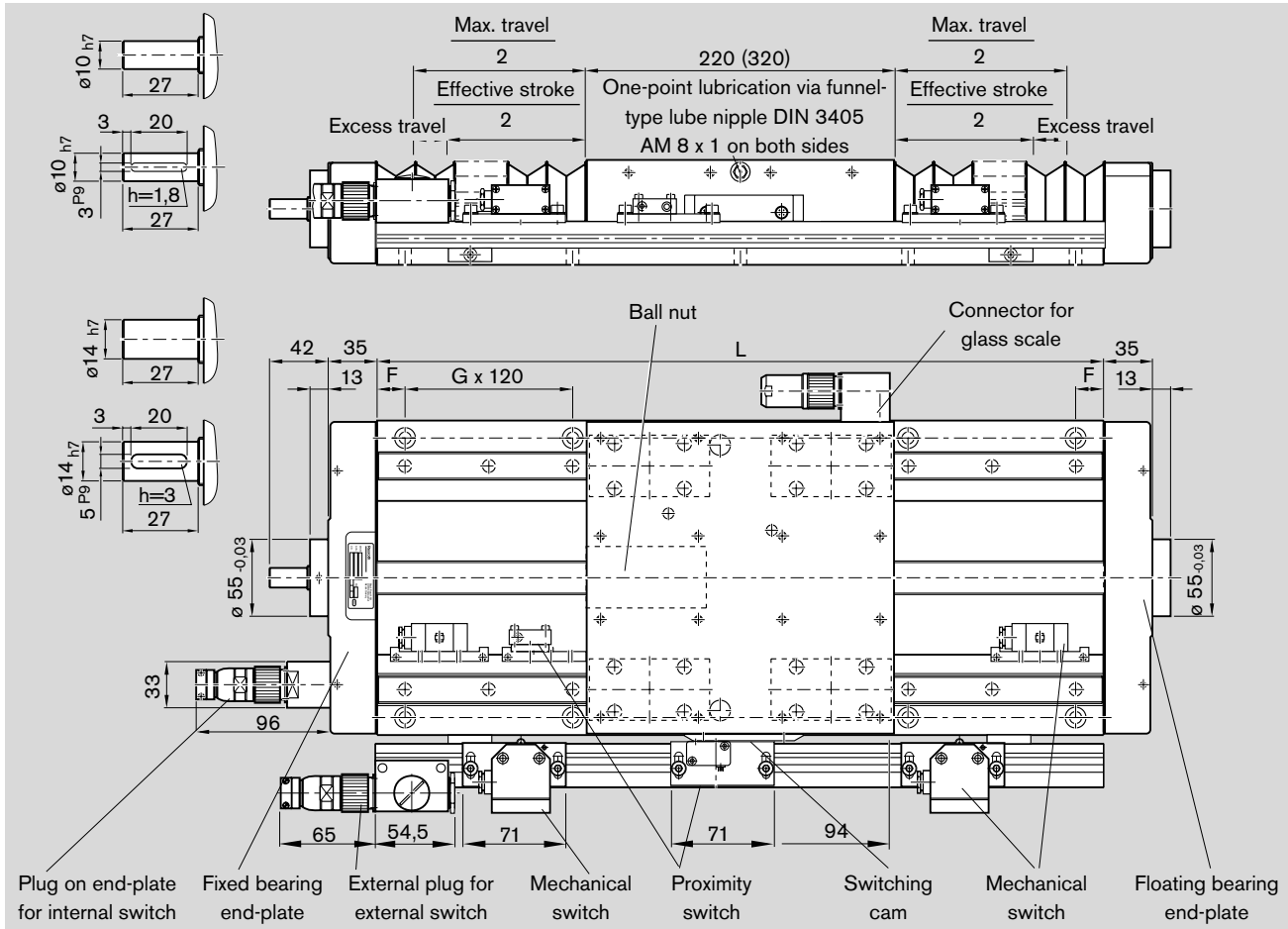

Length L (mm)	Counterbored mounting hole spacing F - G x 120 - F	Max. travel (mm) for carriage length			
		with bellows		without bellows	
340	50 - 2 - 120 - 50	70	-	110	-
400	20 - 3 - 120 - 20	122	-	170	-
460	50 - 3 - 120 - 50	174	86	230	130
520	20 - 4 - 120 - 20	226	138	290	190
580	50 - 4 - 120 - 50	278	190	350	250
640	20 - 5 - 120 - 20	330	242	410	310
700	50 - 5 - 120 - 50	382	294	470	370
760	20 - 6 - 120 - 20	434	346	530	430
820	50 - 6 - 120 - 50	486	398	590	490
880	20 - 7 - 120 - 20	538	450	650	550
940	50 - 7 - 120 - 50	590	502	710	610
1000	20 - 8 - 120 - 20	642	554	770	670
1060	50 - 8 - 120 - 50	694	606	830	730
1120	20 - 9 - 120 - 20	746	658	890	790
1180	50 - 9 - 120 - 50	798	710	950	850
1240	20 - 10 - 120 - 20	850	762	1010	910
1300	50 - 10 - 120 - 50	902	814	1070	970
1360	20 - 11 - 120 - 20	954	866	1130	1030
1420	50 - 11 - 120 - 50	1006	918	1190	1090
1480	20 - 12 - 120 - 20	1058	970	1250	1150
1540	50 - 12 - 120 - 50	1110	1022	1310	1210
1600	20 - 13 - 120 - 20	1162	1074	1370	1270

Length L (mm)	Counterbored mounting hole spacing F - G x 120 - F	Max. travel (mm) for carriage length			
		with bellows		without bellows	
1660	50 - 13 x 120 - 50	1214	1126	1430	1330
1720	20 - 14 x 120 - 20	1266	1178	1490	1390
1780	50 - 14 x 120 - 50	1318	1230	1550	1450
1840	20 - 15 x 120 - 20	1370	1282	1610	1510
1900	50 - 15 x 120 - 50	1422	1334	1670	1570
1960	20 - 16 x 120 - 20	1474	1386	1730	1630
2020	50 - 16 x 120 - 50	1526	1438	1790	1690
2080	20 - 17 x 120 - 20	1578	1490	1850	1750
2140	50 - 17 x 120 - 50	1630	1542	1910	1810
2200	20 - 18 x 120 - 20	1682	1594	1970	1870
2260	50 - 18 x 120 - 50	1734	1646	2030	1930
2320	20 - 19 x 120 - 20	1786	1698	2090	1990
2380	50 - 19 x 120 - 50	1838	1750	2150	2050

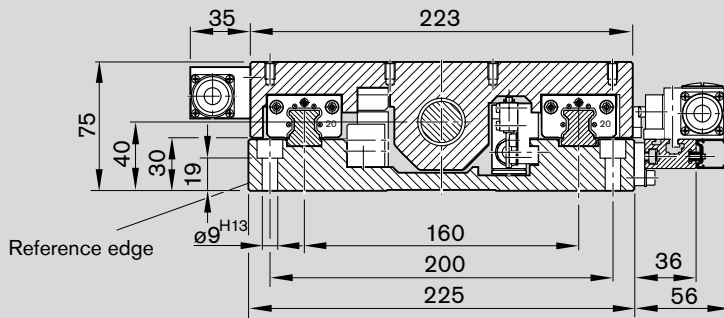

Mounting hole pattern for carriage length $L_{ca} = 220$

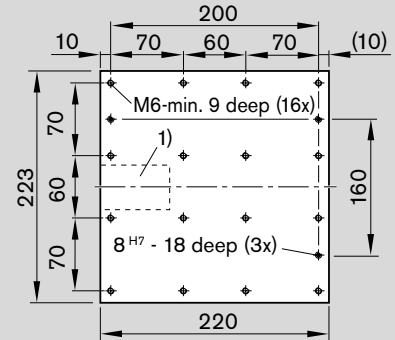

Mounting hole pattern for carriage length $L_{ca} = 320$

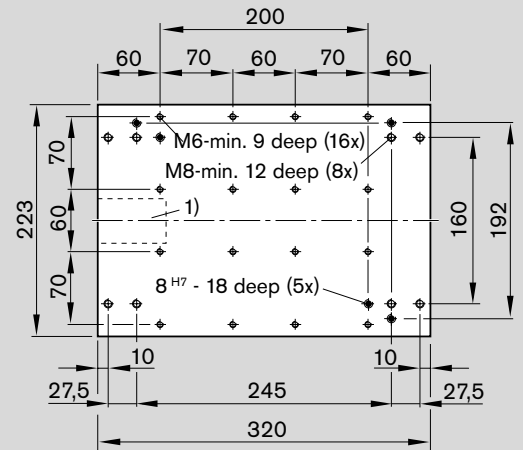

View on end face

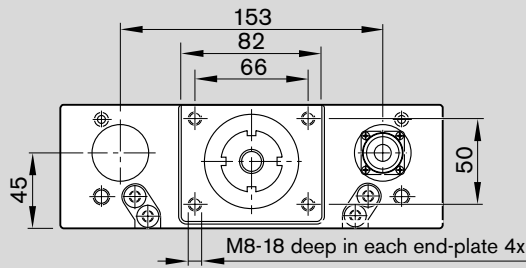

1) Ball nut

Effective stroke

For safe operation, the excess travel must be longer than the braking distance. The acceleration travel can be taken as a guideline value for the braking distance. In most cases, 2x the ball screw lead (P) will be sufficient. Example for P = 5 mm: Excess travel (braking distance) ≈ 10 mm Recommended standard configuration:
 - 2 mechanical switches
 - 1 proximity switch

$$\text{Effective stroke} = \text{max. travel} - 2 \cdot \text{excess travel}$$

Distance between switch activation points of two switches

Switch position	For switch combination	Min. spacing (mm)
external	mechanical – mechanical	62.0
	mechanical – proximity	49.0
	proximity – proximity	35.0
internal	mechanical – mechanical	70.0
	mechanical – proximity	50.0
	proximity – proximity	25.0

Maximum switch activation point

The switch activation point characterizes the position of the center of the carriage after travel. The zero point is at L/2.

$$\text{Maximum switch activation point} = 0.5 \cdot \text{max. travel} - \text{excess travel}$$

TKK 20-225 – Dimension Drawings, Motor Attachment

Motor attachment with motor mount and coupling

MF01, MF02

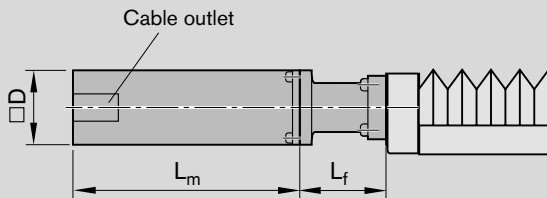

Motor	Dimensions (mm)		
	L_m	D	L_f
MSK 040C	185.5 ¹⁾	82	90
	215.5 ²⁾		
MSM 040B	157.5 ¹⁾	80	90
	191.5 ²⁾		
MSK 050C	203.0 ¹⁾	98	115
	233.0 ²⁾		
VRDM 397	110.0 ¹⁾	85	90
	156.5 ²⁾		
VRDM 3910	140.0 ¹⁾		
	186.5 ²⁾		
VRDM 3913	170.0 ¹⁾		
	216.5 ²⁾		

1) Without brake

2) With brake

Motor attachment via timing belt side drive

RV01 - RV04

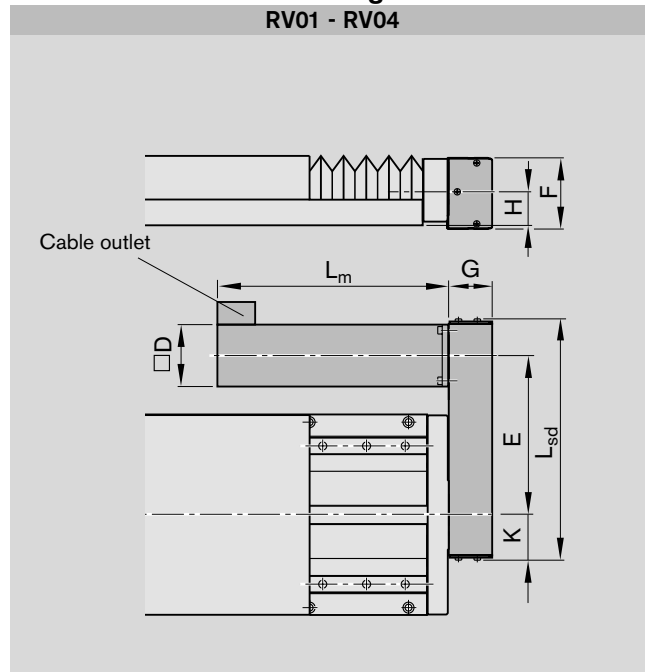

Motor	Dimensions (mm)										
	L _m	D	G	H	L _{sd}	i = 1	i = 1.5	i = 2	E	K	F
MSK 040C	185.5 ¹⁾ 215.5 ²⁾	82	51	40	322	210.0	213.5	-	47.5	88	
MSM 040B	157.5 ¹⁾ 191.5 ²⁾										
MSK 050C	203.0 ¹⁾ 233.0 ²⁾	98	66	40	367	230.0	-	235.0	56.0	116	

RV05, RV06

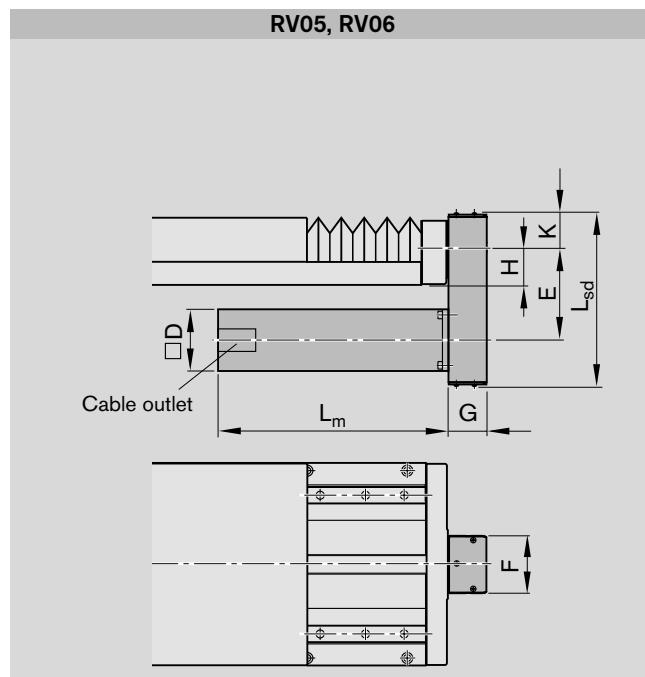

Motor	Dimensions (mm)										
	L _m	D	G	H	L _{sd}	i = 1	i = 1.5	i = 2	E	K	F
MSK 040C	185.5 ¹⁾ 215.5 ²⁾	82	51	40	231	122.5	122.0	-	47.5	88	
MSM 040B	157.5 ¹⁾ 191.5 ²⁾										
MSK 050C	203.0 ¹⁾ 233.0 ²⁾	98	66	40	287	155.0	-	155.0	56.0	116	

- 1) Without brake
- 2) With brake

Note for steel version

In type RV01 and RV02 with externally mounted switches:
 - No switches may be mounted in the motor area!

Note for multi-axis units

(e.g. X-Y tables)

For multi-axis units with motor attachment via timing belt side drive, the motor may project into the working area of adjacent axes. Check for any interference contours.

For motor dimensions, see "Motors."



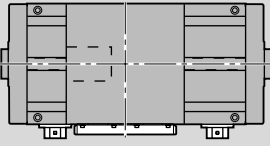
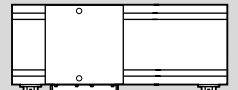
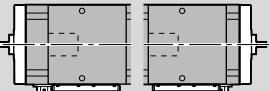
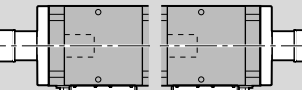
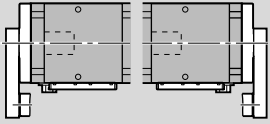
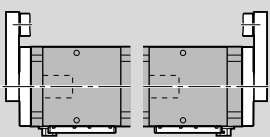
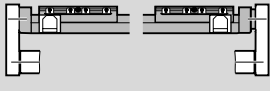

TKK 30-325 AI Components and Ordering

Part number, length R1460 405 00, ... mm Reference edge  Switches	Dimension drawing	Guideway		Drive unit				Carriage				
		low	high	Ball screw journal keyway	Ball screw			320 mm Preload		450 mm Preload		
					32 x 5	32 x 10	32 x 20	32 x 32	2%	8%	2%	8%
Without drive (without end-plates) OA01 	OA01	01	11		00				05	06	07	08
Without motor mount and motor OF01  OF04	OF01 OF04	01	11	ø16 (fixed bearing end)	07	13	19	25	05	06	07	08
				ø16 (fixed bearing end) ¹⁾	10	16	22	28				
With motor mount and coupling, with or without motor MF01  MF02	MF01 MF02	01	11	ø16 (fixed bearing end)	07	13	19	25	05	06	07	08
With timing belt side drive, with or without motor RV01  RV02 RV03  RV04 RV05  RV06	RV01 - RV04 RV05 RV06											
		01	11	ø19 (floating bearing end)	09	15	21	27	05	06	07	08

1) With keyway

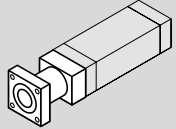
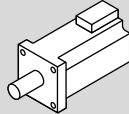
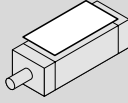
Please check whether the selected combination is a permissible one (load capacities, moments, maximum speeds, motor data, etc.)!

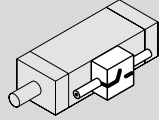
For more information on ordering, see order example.

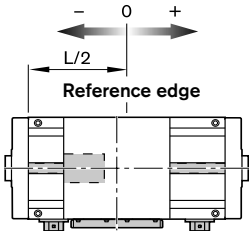
i	Motor attachment ²⁾ Mounting orientation		Motor		Cover PU bellows		Position meas- uring system		Switches (1st, 2nd, 3rd), switching cam, socket, plug, cable duct		Documentation									
																				
			without	00	without	with	with- out	Glass scale			Standard report	Special report								
	OA01	00	without	00	00	on re- quest														
	OF01-OF04	00	without	00								02 Friction moment								
1	MF01-MF02	09	MSK 060C	90 ³⁾								03 Lead deviation								
		08	MSK 076C	91 ⁴⁾	92 ³⁾	93 ⁴⁾														
1	RV01-RV04	77	MSK 060C	90 ³⁾	00	01	00	on re- quest	00	Direction  Switches Internal switches PNP NC 01-I +/-... mm PNP NO 03-I +/-... mm Mechanical 05-I +/-... mm External switches PNP NC 11-A +/-... mm PNP NO 13-A +/-... mm Mechanical 15-A +/-... mm Cable duct (loose) Cable duct 20 - X...	01	04 Travel accuracy								
	RV05-RV06	78																		
2	RV01-RV04	79										91 ⁴⁾								05 Positioning accuracy
	RV05-RV06	80																		

2) Attachment kit also available without motor (when ordering enter "00" for motor)
 3) Without brake
 4) With brake

----- Optional

TKK 30-325 AI – Dimensions

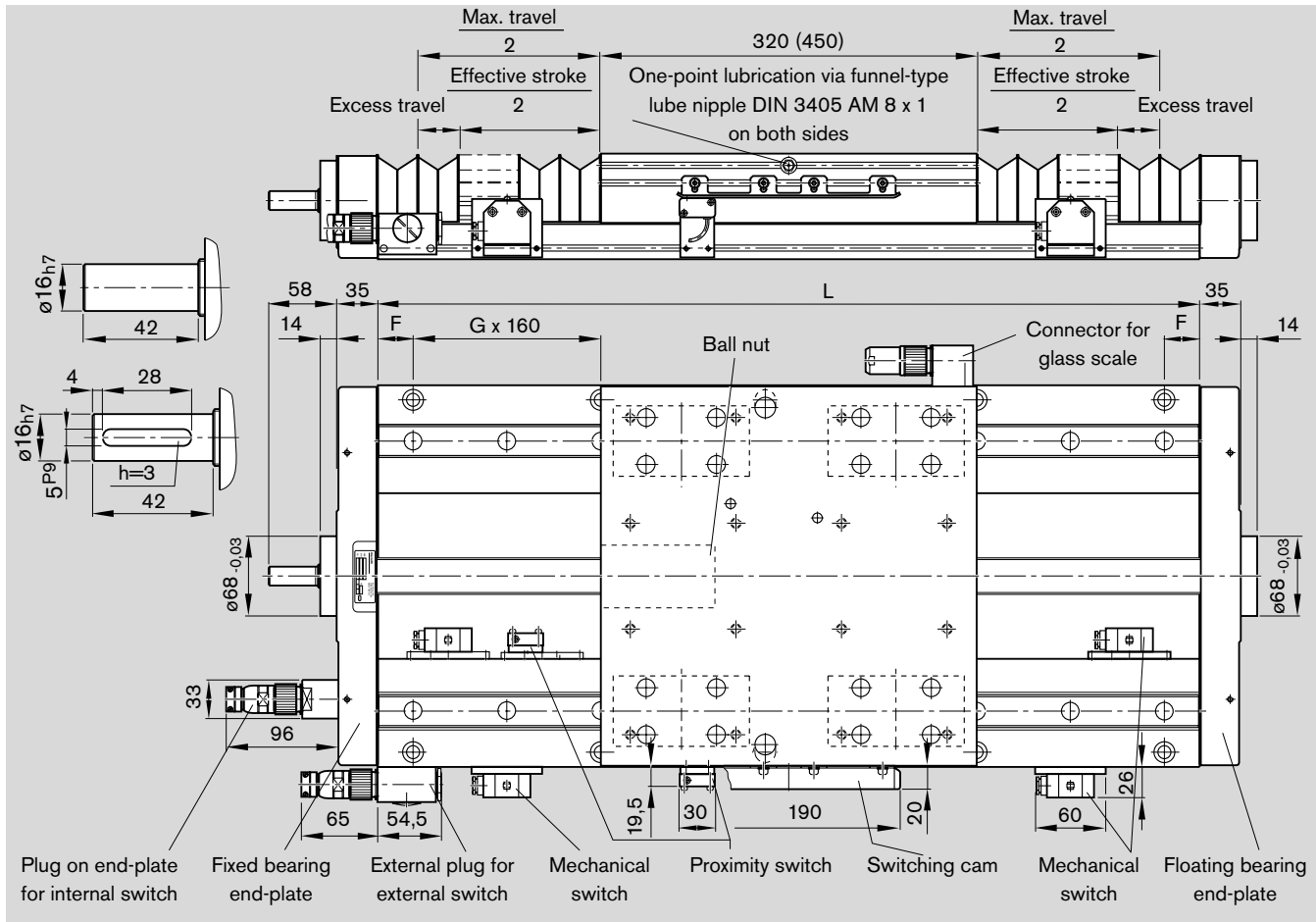

Length L (mm)	Counterbored mounting hole spacing F - G x 160 - F	Max. travel (mm) for carriage length			
		with bellows		without bellows	
540	30 - 3 x 160 - 30	154	-	210	-
620	70 - 3 x 160 - 70	225	109	290	160
700	30 - 4 x 160 - 30	297	180	370	240
780	70 - 4 x 160 - 70	368	251	450	320
860	30 - 5 x 160 - 30	439	322	530	400
940	70 - 5 x 160 - 70	510	394	610	480
1020	30 - 6 x 160 - 30	582	465	690	560
1100	70 - 6 x 160 - 70	653	536	770	640
1180	30 - 7 x 160 - 30	724	604	850	720
1260	70 - 7 x 160 - 70	795	679	930	800
1340	30 - 8 x 160 - 30	866	750	1010	880
1420	70 - 8 x 160 - 70	938	821	1090	960
1500	30 - 9 x 160 - 30	1009	892	1170	1040
1580	70 - 9 x 160 - 70	1080	963	1250	1120
1660	30 - 10 x 160 - 30	1151	1035	1330	1200

Length L (mm)	Counterbored mounting hole spacing F - G x 160 - F	Max. travel (mm) for carriage length			
		with bellows		without bellows	
1740	70 - 10 x 160 - 70	1223	1106	1410	1280
1820	30 - 11 x 160 - 30	1294	1177	1490	1360
1900	70 - 11 x 160 - 70	1365	1248	1570	1440
1980	30 - 12 x 160 - 30	1436	1320	1650	1520
2060	70 - 12 x 160 - 70	1507	1391	1730	1600
2140	30 - 13 x 160 - 30	1579	1462	1810	1680
2220	70 - 13 x 160 - 70	1650	1533	1890	1760
2300	30 - 14 x 160 - 30	1721	1605	1970	1840
2380	70 - 14 x 160 - 70	1792	1676	2050	1920
2460	30 - 15 x 160 - 30	1864	1747	2130	2000
2540	70 - 15 x 160 - 70	1935	1818	2210	2080
2620	30 - 16 x 160 - 30	2006	1889	2290	2160
2700	70 - 16 x 160 - 70	2077	1961	2370	2240
2780	30 - 17 x 160 - 30	2148	2032	2450	2320
2860	70 - 17 x 160 - 70	2220	2103	2530	2400

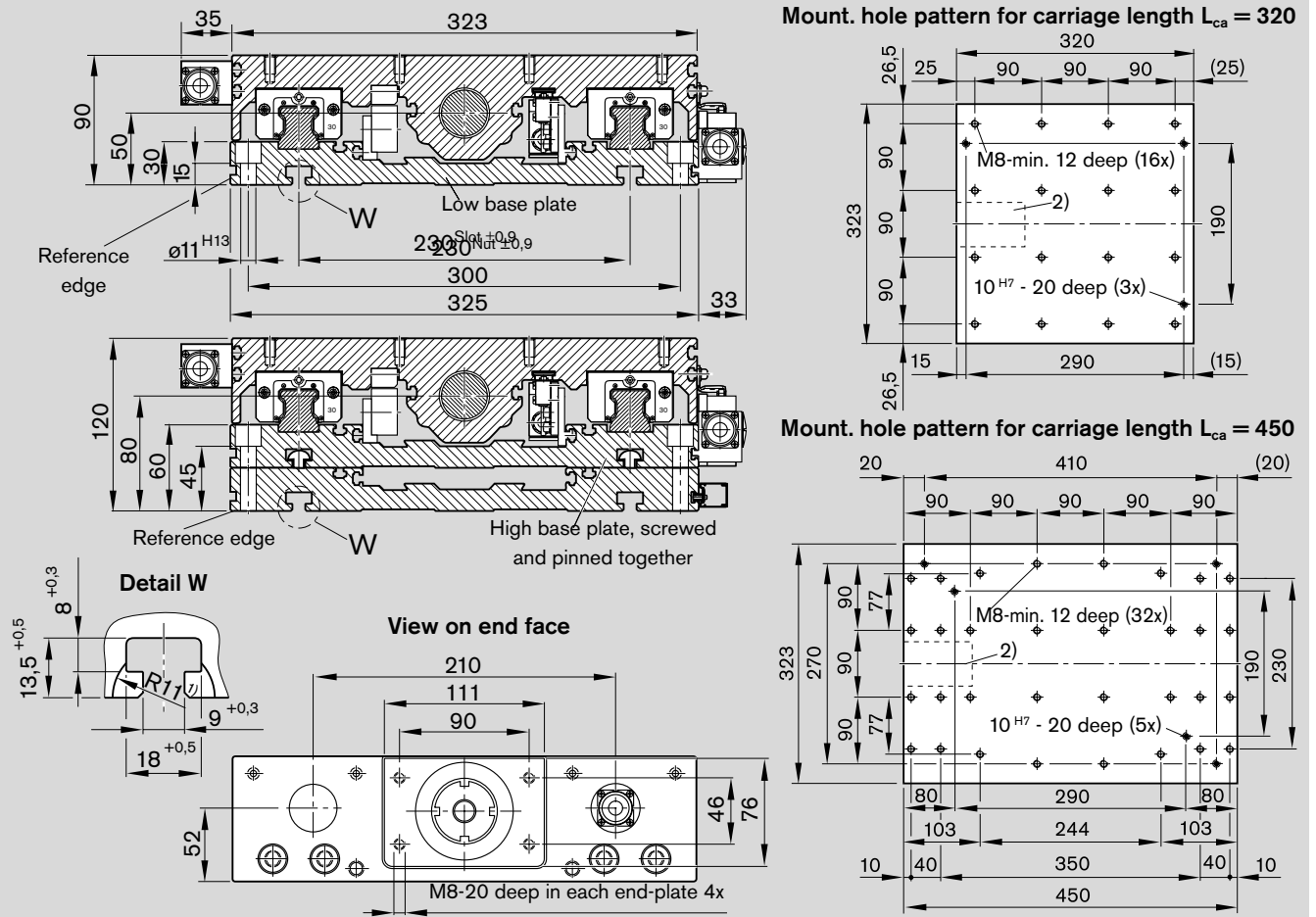

- 1) 27 deep (4x)
- 2) Ball nut

Effective stroke

For safe operation, the excess travel must be longer than the braking distance. The acceleration travel can be taken as a guideline value for the braking distance. In most cases, 2x the ball screw lead (P) will be sufficient. Example for P = 5 mm:

Excess travel (braking distance) ≈ 10 mm

Recommended standard configuration:

- 2 mechanical switches
- 1 proximity switch

$$\text{Effective stroke} = \text{max. travel} - 2 \cdot \text{excess travel}$$

Distance between switch activation points of two switches

Switch position	For switch combination	Min. spacing (mm)
external	mechanical – mechanical	60.0
	mechanical – proximity	45.0
	proximity – proximity	12.5
internal	mechanical – mechanical	70.0
	mechanical – proximity	50.0
	proximity – proximity	25.0

Maximum switch activation point

The switch activation point characterizes the position of the center of the carriage after travel. The zero point is at L/2.

$$\text{Maximum switch activation point} = 0.5 \cdot \text{max. travel} - \text{excess travel}$$

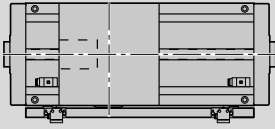
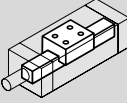
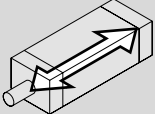
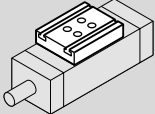
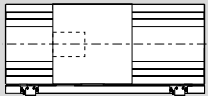
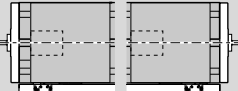
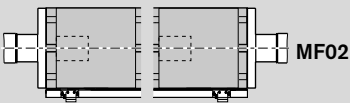
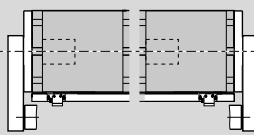
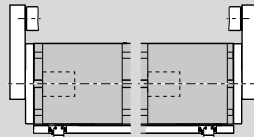
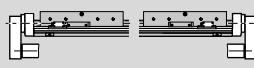

TKK 30-325 St Components and Ordering

Part number, length R1460 400 00, ... mm Reference edge  Switches	Dimension drawing	Guideway  Base plate, low	Drive unit  Ball screw journal keyway				Carriage  Carriage length L _{ca}					
				Ball screw								
				32 x 5				320 mm		450 mm		
				32 x 10				Preload		Preload		
				32 x 20				2%		2%		
				32 x 32				8%		8%		
Without drive (without end-plates) OA01 	OA01	01	00				05	06	07	08		
Without motor mount and motor OF01 OF04 	OF01 OF04	01	$\varnothing 16$ (fixed bearing end)	07	13	19	25	05	06	07	08	
				$\varnothing 16$ (fixed bearing end) ¹⁾	10	16	22	28				
With motor mount and coupling, with or without motor MF01 MF02 	MF01 MF02	01	$\varnothing 16$ (fixed bearing end)	07	13	19	25	05	06	07	08	
With timing belt side drive, with or without motor RV01 RV02  RV03 RV04  RV05 RV06 	RV01-RV04 RV05 RV06	01 01	$\varnothing 19$ (floating bearing end)	09	15	21	27	05	06	07	08	

1) With keyway

Please check whether the selected combination is a permissible one (load capacities, moments, maximum speeds, motor data, etc.)!

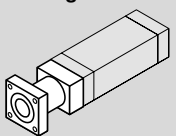
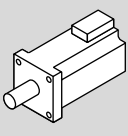
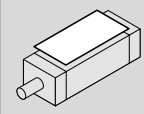
For more information on ordering, see order example.

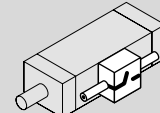
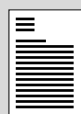
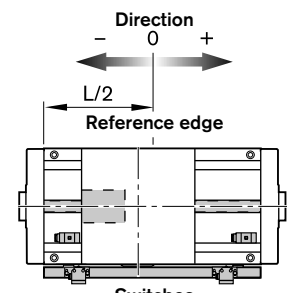
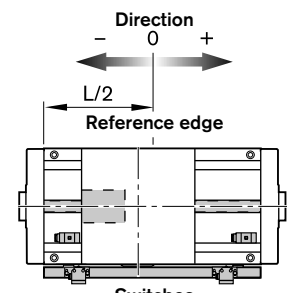
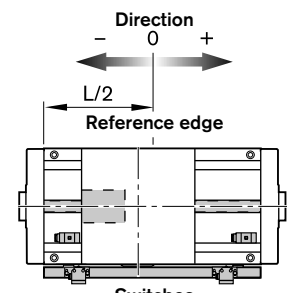
i	Motor attachment ²⁾ Mounting orientation		Motor		Cover PU bellows		Position meas- uring system		Switches (1st, 2nd, 3rd), switching cam, socket, plug, cable duct		Documentation																																																		
																																																													
			without	00	without	with	with- out	Glass scale			Standard report	Special report																																																	
	OA01	00	without	00	00	on re- quest																																																							
	OF01-OF04	00	without	00								02 Friction moment																																																	
1	MF01-MF02	09	MSK 060C	90 ³⁾ 91 ⁴⁾								03 Lead deviation																																																	
		08	MSK 076C	92 ³⁾ 93 ⁴⁾																																																									
1	RV01-RV04	77	MSK 060C	90 ³⁾	00	01	00	on request			01	04 Travel accuracy																																																	
	RV05-RV06	78																																																											
2	RV01-RV04	79				91 ⁴⁾								05 Positioning accuracy																																															
	RV05-RV06	80																																																											
										<table border="1"> <tr> <td colspan="3">Without switches</td> </tr> <tr> <td>without switch</td> <td></td> <td rowspan="2">00</td> </tr> <tr> <td>without cable duct</td> <td></td> </tr> <tr> <td colspan="3">With switches</td> </tr> <tr> <td colspan="3">  </td> </tr> <tr> <td colspan="3">Internal switches</td> </tr> <tr> <td>PNP NC</td> <td rowspan="4">Socket/plug on end-plate, switching cam</td> <td rowspan="4">07</td> </tr> <tr> <td>01-I +/-... mm</td> </tr> <tr> <td>PNP NO</td> </tr> <tr> <td>03-I +/-... mm</td> </tr> <tr> <td>Mechanical</td> <td></td> <td></td> </tr> <tr> <td>05-I +/-... mm</td> <td></td> <td></td> </tr> <tr> <td colspan="3">External switches</td> </tr> <tr> <td>PNP NC</td> <td rowspan="3">Switch- ing cam, external</td> <td rowspan="3">26</td> </tr> <tr> <td>11-A +/-... mm</td> </tr> <tr> <td>PNP NO</td> </tr> <tr> <td>13-A +/-... mm</td> <td rowspan="2">External socket/ plug (loose)</td> <td rowspan="2">17</td> </tr> <tr> <td>Mechanical</td> </tr> <tr> <td>15-A +/-... mm</td> <td></td> <td></td> </tr> <tr> <td colspan="3">Cable duct (loose)</td> </tr> <tr> <td>Cable duct</td> <td></td> <td>20 - X...</td> </tr> </table>		Without switches			without switch		00	without cable duct		With switches						Internal switches			PNP NC	Socket/plug on end-plate, switching cam	07	01-I +/-... mm	PNP NO	03-I +/-... mm	Mechanical			05-I +/-... mm			External switches			PNP NC	Switch- ing cam, external	26	11-A +/-... mm	PNP NO	13-A +/-... mm	External socket/ plug (loose)	17	Mechanical	15-A +/-... mm			Cable duct (loose)			Cable duct		20 - X...
Without switches																																																													
without switch		00																																																											
without cable duct																																																													
With switches																																																													
																																																													
Internal switches																																																													
PNP NC	Socket/plug on end-plate, switching cam	07																																																											
01-I +/-... mm																																																													
PNP NO																																																													
03-I +/-... mm																																																													
Mechanical																																																													
05-I +/-... mm																																																													
External switches																																																													
PNP NC	Switch- ing cam, external	26																																																											
11-A +/-... mm																																																													
PNP NO																																																													
13-A +/-... mm	External socket/ plug (loose)	17																																																											
Mechanical																																																													
15-A +/-... mm																																																													
Cable duct (loose)																																																													
Cable duct		20 - X...																																																											

2) Attachment kit also available without motor (when ordering enter "00" for motor)

3) Without brake

4) With brake

----- Optional

TKK 30-325 St – Dimensions

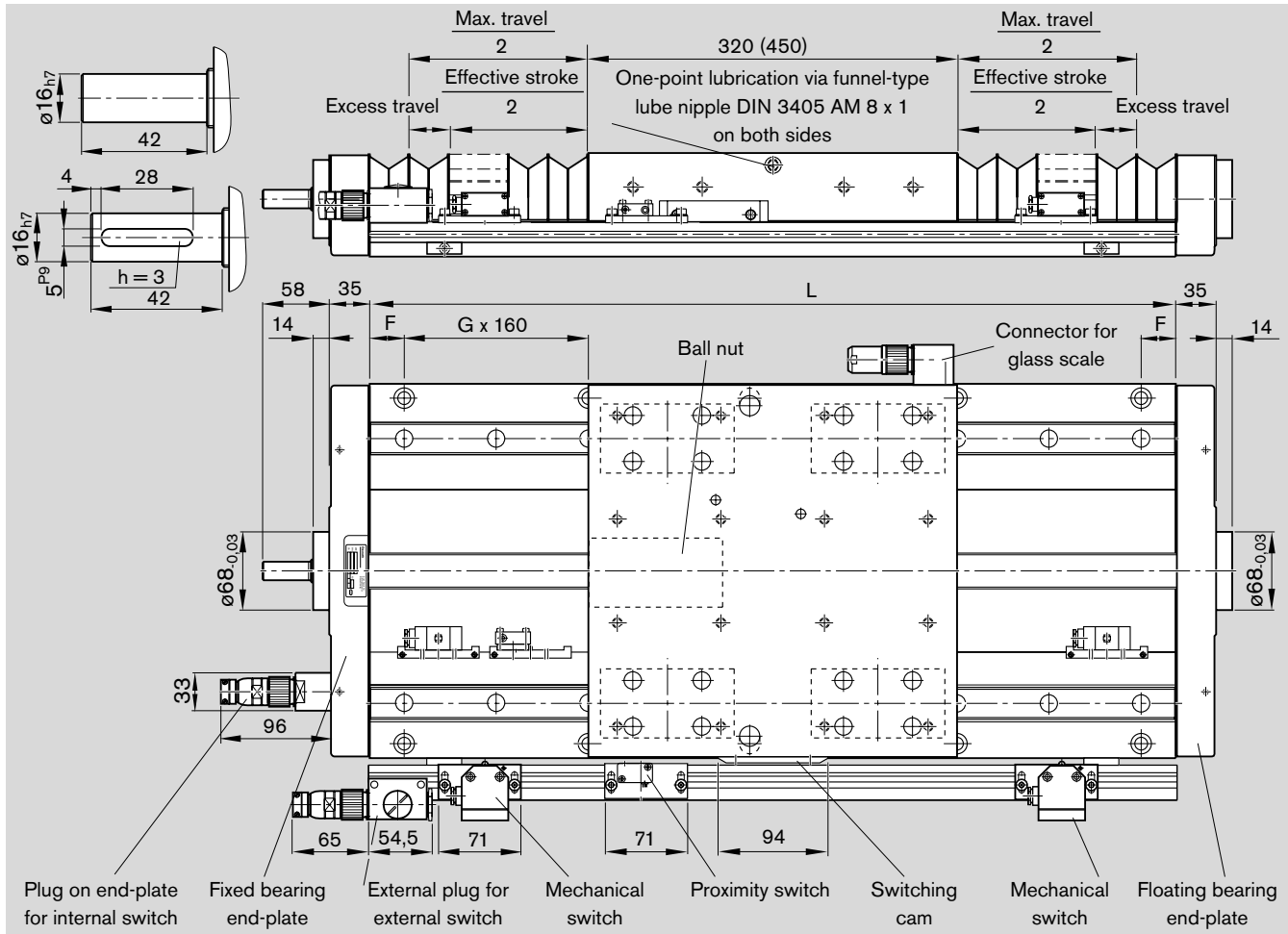

Length L (mm)	Counterbored mounting hole spacing F - G x 160 - F	Max. travel (mm) for carriage length			
		with bellows		without bellows	
540	30 - 3 x 160 - 30	320	450	320	450
620	70 - 3 x 160 - 70	154	-	210	-
700	30 - 4 x 160 - 30	225	109	290	160
780	30 - 4 x 160 - 30	297	180	370	240
860	70 - 4 x 160 - 70	368	251	450	320
940	30 - 5 x 160 - 30	439	322	530	400
1020	70 - 5 x 160 - 70	510	394	610	480
1100	30 - 6 x 160 - 30	582	465	690	560
1180	70 - 6 x 160 - 70	653	536	770	640
1260	30 - 7 x 160 - 30	724	604	850	720
1340	70 - 7 x 160 - 70	795	679	930	800
1420	30 - 8 x 160 - 30	866	750	1010	880
1500	70 - 8 x 160 - 70	938	821	1090	960
1580	30 - 9 x 160 - 30	1009	892	1170	1040
1660	70 - 9 x 160 - 70	1080	963	1250	1120
1740	30 - 10 x 160 - 30	1151	1035	1330	1200

Length L (mm)	Counterbored mounting hole spacing F - G x 160 - F	Max. travel (mm) for carriage length			
		with bellows		without bellows	
1740	70 - 10 x 160 - 70	1223	1106	1410	1280
1820	30 - 11 x 160 - 30	1294	1177	1490	1360
1900	70 - 11 x 160 - 70	1365	1248	1570	1440
1980	30 - 12 x 160 - 30	1436	1320	1650	1520
2060	70 - 12 x 160 - 70	1507	1391	1730	1600
2140	30 - 13 x 160 - 30	1579	1462	1810	1680
2220	70 - 13 x 160 - 70	1650	1533	1890	1760
2300	30 - 14 x 160 - 30	1721	1605	1970	1840
2380	70 - 14 x 160 - 70	1792	1676	2050	1920

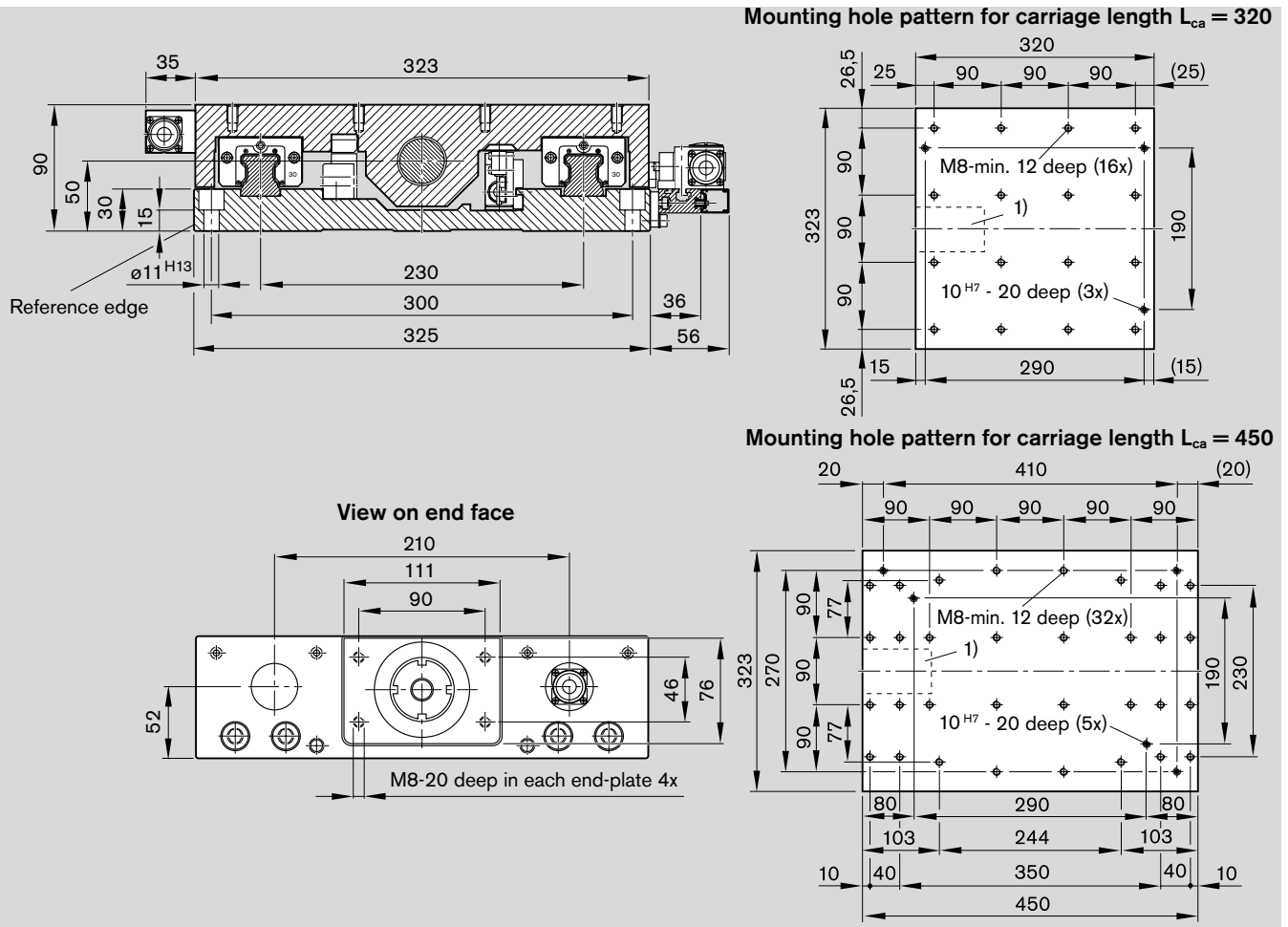

1) Ball nut

Effective stroke

For safe operation, the excess travel must be longer than the braking distance. The acceleration travel can be taken as a guideline value for the braking distance. In most cases, 2x the ball screw lead (P) will be sufficient. Example for P = 5 mm:

Excess travel (braking distance) ≈ 10 mm

Recommended standard configuration:

- 2 mechanical switches
- 1 proximity switch

$$\text{Effective stroke} = \text{max. travel} - 2 \cdot \text{excess travel}$$

Distance between switch activation points of two switches

Switch position	For switch combination	Min. spacing (mm)
external	mechanical – mechanical	62.0
	mechanical – proximity	49.0
	proximity – proximity	35.0
internal	mechanical – mechanical	70.0
	mechanical – proximity	50.0
	proximity – proximity	25.0

Maximum switch activation point

The switch activation point characterizes the position of the center of the carriage after travel. The zero point is at L/2.

$$\text{Maximum switch activation point} = 0.5 \cdot \text{max. travel} - \text{excess travel}$$

TKK 30-325 – Dimension Drawings, Motor Attachment

Motor attachment with motor mount and coupling

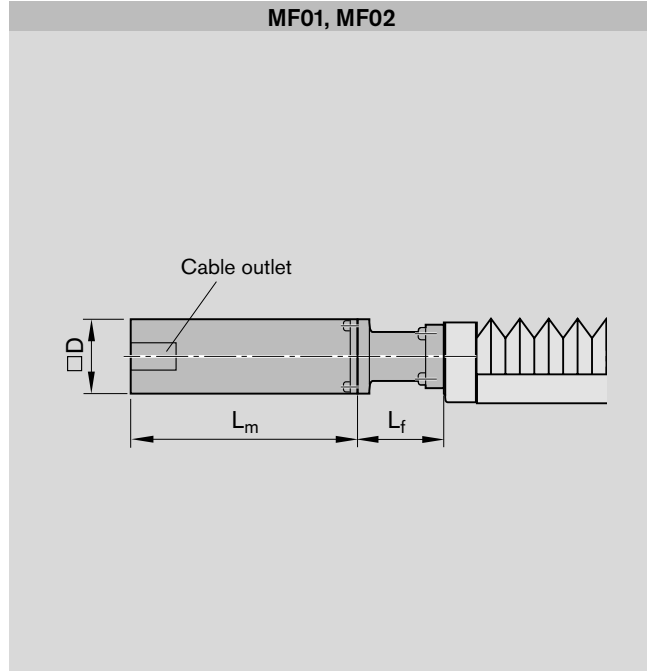

Motor	Dimensions (mm)		
	L_m	D	L_f
MSK 060C	226.0 ¹⁾	115	125
	259.0 ²⁾		
MSK 076C	292.5 ¹⁾²⁾	140	133

1) Without brake

2) With brake

Motor attachment via timing belt side drive

RV01 - RV04

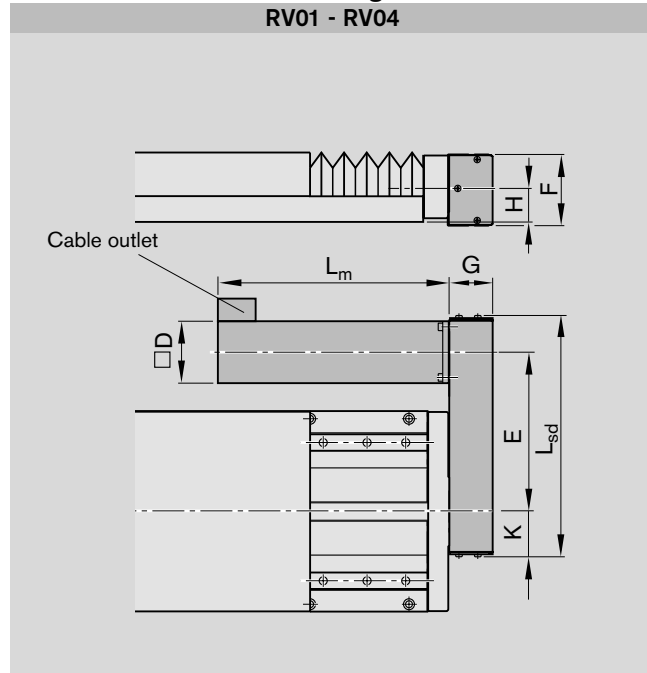

Motor	Dimensions (mm)									
	L _m	D	G	H	L _{sd}	i = 1	i = 2	E	K	F
MSK 060C	226 ¹⁾ 259 ²⁾	82	51	50	403	267.5	265	56	116	

RV05, RV06

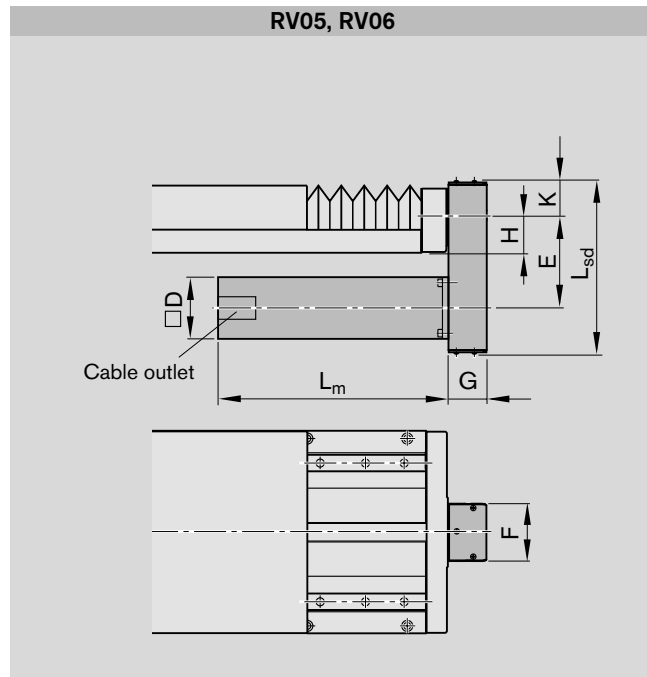

Motor	Dimensions (mm)									
	L _m	D	G	H	L _{sd}	i = 1	i = 2	E	K	F
MSK 060C	226 ¹⁾ 259 ²⁾	82	51	50	300	165	162	56	116	

- 1) Without brake
- 2) With brake

Note for steel version

In type RV01 and RV02 with externally mounted switches:
 – No switches may be mounted in the motor area!

For motor dimensions, see “Motors.”

Note for multi-axis units

(e.g. X-Y tables)

For multi-axis units with motor attachment via timing belt side drive, the motor may project into the working area of adjacent axes. Check for any interference contours.

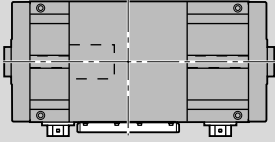
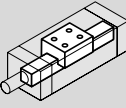
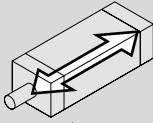
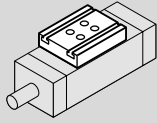
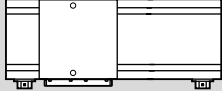
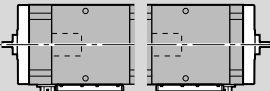
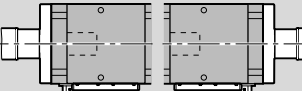
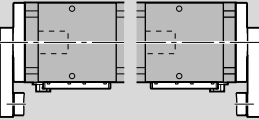
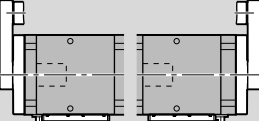
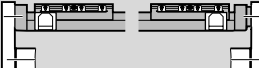

TKK 35-455 AI Components and Ordering

Part number, length R1460 505 00, ... mm Reference edge  Switches	Dimension drawing	Guideway  Base plate, low	Drive unit  Ball screw journal keyway Ball screw 40 x 5 40 x 10 40 x 20 40 x 40				Carriage  Carriage length L _{ca} 450 mm Preload 2% 8%	
Without drive (without end-plates) OA01 	OA01	01	00				05 06	
Without motor mount and motor OF01  OF04	OF01 OF04	01	ø25 (fixed bearing end)	25	31	37	43	05 06
With motor mount and coupling, with or without motor MF01  MF02	MF01 MF02	01	ø25 (fixed bearing end)	25	31	37	43	05 06
With timing belt side drive, with or without motor RV01  RV02 RV03  RV04 RV05  RV06	RV01-RV04 RV05 RV06	01	ø24 (floating bearing end)	27	33	39	45	05 06

1) With keyway

Please check whether the selected combination is a permissible one (load capacities, moments, maximum speeds, motor data, etc.)!

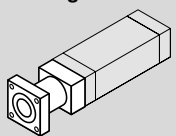
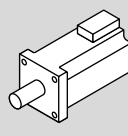
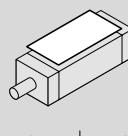
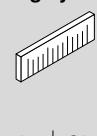
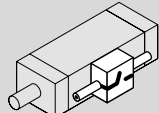
For more information on ordering, see order example.

Motor attachment Mounting orientation	Motor		Cover PU bellows		Position meas- uring system		Switches (1st, 2nd, 3rd), switching cam, socket, plug, cable duct	Documentation	
									
i	without	with	without	with	without	Glass scale	Standard report	Special report	
OA01	00	without	00	00	on request		01	02	Friction moment
OF01-OF04	00	without	00				01	03	Lead deviation
1 MF01-MF02	08	MSK 076C	92 ²⁾	93 ³⁾			01	04	Travel accuracy
1 RV01-RV04	53	MSK 076C	92 ²⁾	00	01	00 on request	01	05	Positioning accuracy
RV05-RV06	54								
2 RV01-RV04	55								
RV05-RV06	56	93 ³⁾							

Without switches

without switch	00
without cable duct	

With switches

Direction

- 0 +

L/2

Reference edge

Switches

Internal switches

PNP NC	Socket/plug on end-plate, switching cam
01-l +/-... mm	
PNP NO	
03-l +/-... mm	
Mechanical	07
05-l +/-... mm	

External switches

PNP NC	Switching cam, external	External socket/plug (loose)
11-A +/-... mm		
PNP NO		
13-A +/-... mm		
Mechanical	16	17
15-A +/-... mm		

Cable duct (loose)

Cable duct	20 - X...
------------	-----------

2) Without brake
3) With brake

..... Optional

TKK 35-455 AI – Dimensions

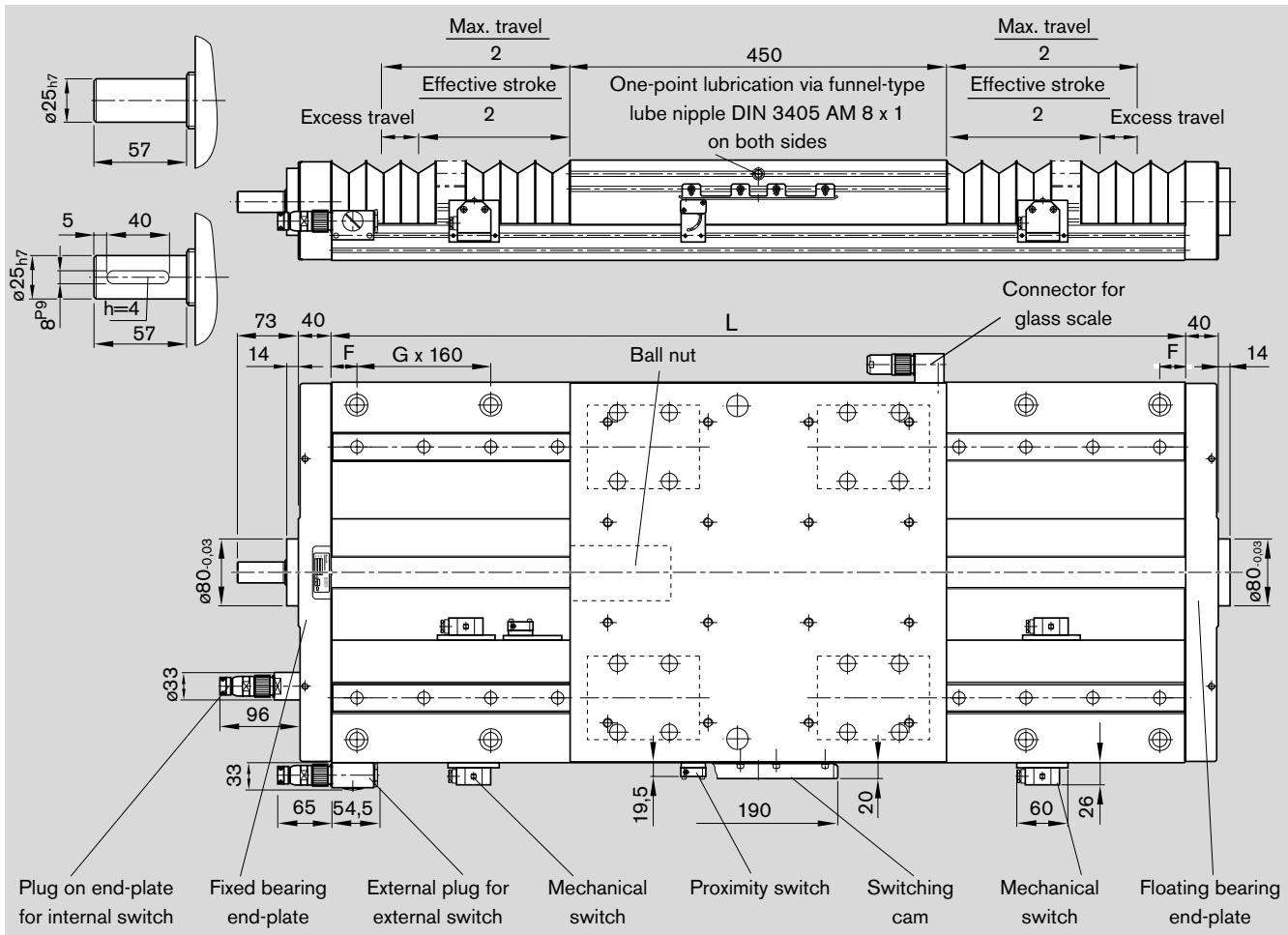

Length L (mm)	Counterbored mounting hole spacing F - G x 160 - F	Max. travel (mm)	
		with bellows	without bellows
620	70 - 3 x 160 - 70	110	160
700	30 - 4 x 160 - 30	183	240
780	70 - 4 x 160 - 70	256	320
860	30 - 5 x 160 - 30	328	400
940	70 - 5 x 160 - 70	401	480
1020	30 - 6 x 160 - 30	474	560
1100	70 - 6 x 160 - 70	546	640
1180	30 - 7 x 160 - 30	619	720
1260	70 - 7 x 160 - 70	692	800
1340	30 - 8 x 160 - 30	766	880
1420	70 - 8 x 160 - 70	837	960
1500	30 - 9 x 160 - 30	910	1040
1580	70 - 9 x 160 - 70	982	1120
1660	30 - 10 x 160 - 30	1055	1200
1740	70 - 10 x 160 - 70	1127	1200

Length L (mm)	Counterbored mounting hole spacing F - G x 160 - F	Max. travel (mm)	
		with bellows	without bellows
1820	30 - 11 x 160 - 30	1200	1360
1900	70 - 11 x 160 - 70	1273	1440
1980	30 - 12 x 160 - 30	1345	1520
2060	70 - 12 x 160 - 70	1418	1600
2140	30 - 13 x 160 - 30	1491	1680
2220	70 - 13 x 160 - 70	1563	1760
2300	30 - 14 x 160 - 30	1636	1840
2380	70 - 14 x 160 - 70	1709	1920
2460	30 - 15 x 160 - 30	1781	2000
2540	70 - 15 x 160 - 70	1854	2080
2620	30 - 16 x 160 - 30	1927	2160
2700	70 - 16 x 160 - 70	1999	2240
2780	30 - 17 x 160 - 30	2072	2320
2860	70 - 17 x 160 - 70	2144	2400

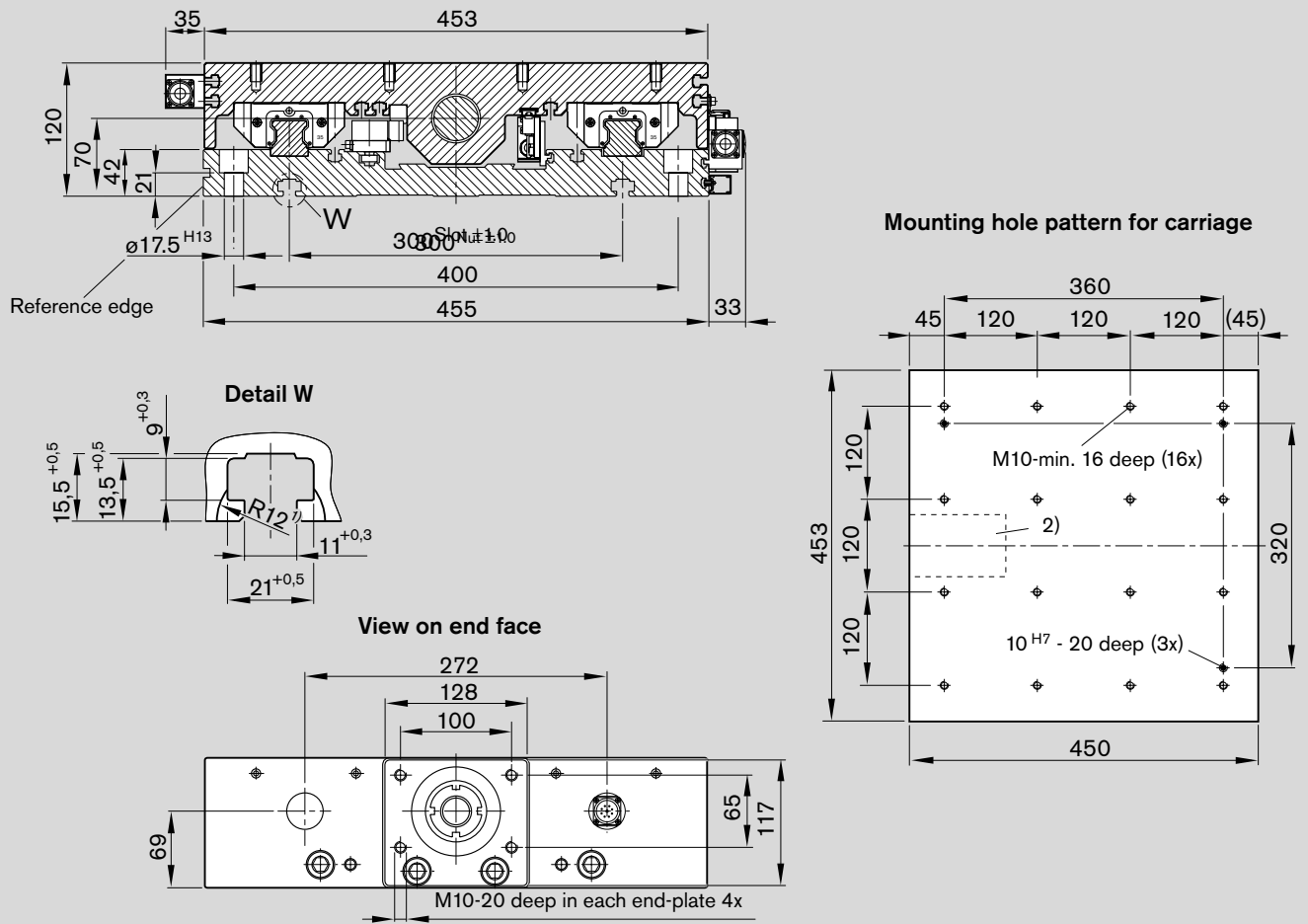

- 1) 27 deep (4x)
- 2) Ball nut

Effective stroke

For safe operation, the excess travel must be longer than the braking distance. The acceleration travel can be taken as a guideline value for the braking distance. In most cases, 2x the ball screw lead (P) will be sufficient. Example for P = 5 mm:

Excess travel (braking distance) ≈ 10 mm

Recommended standard configuration:

- 2 mechanical switches
- 1 proximity switch

$$\text{Effective stroke} = \text{max. travel} - 2 \cdot \text{excess travel}$$

Distance between switch activation points of two switches

Switch position	For switch combination	Min. spacing (mm)
external	mechanical – mechanical	60.0
	mechanical – proximity	45.0
	proximity – proximity	12.5
internal	mechanical – mechanical	70.0
	mechanical – proximity	50.0
	proximity – proximity	25.0

Maximum switch activation point

The switch activation point characterizes the position of the center of the carriage after travel. The zero point is at L/2.

$$\text{Maximum switch activation point} = 0.5 \cdot \text{max. travel} - \text{excess travel}$$

TKK 35-455 AI – Dimension Drawings, Motor Attachment

Motor attachment with motor mount and coupling

MF01, MF02

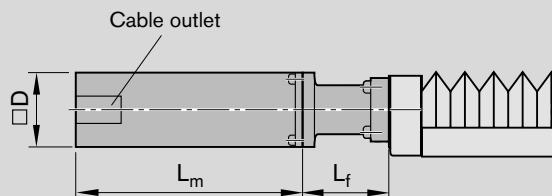

Motor	Dimensions (mm)		
	L_m	D	L_f
MSK 076C	292.5 ¹⁾²⁾	140	140

1) Without brake

2) With brake

Motor attachment via timing belt side drive

RV01 - RV04

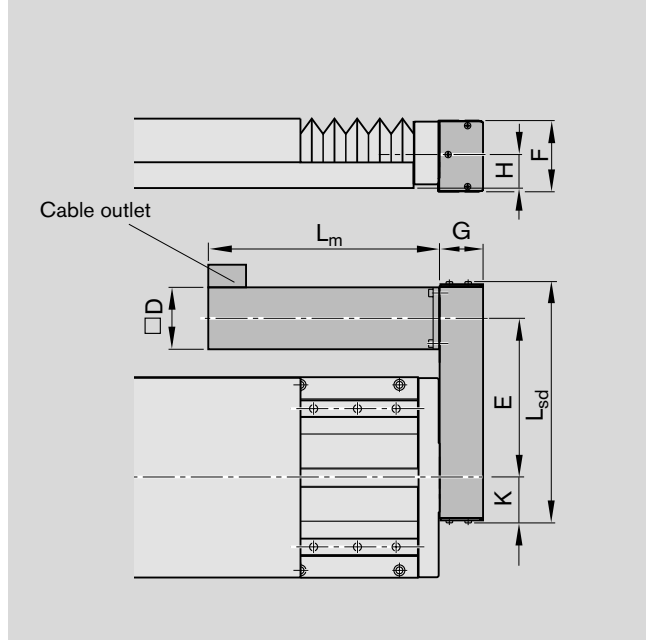

Motor	Dimensions (mm)									
	L _m	D	G	H	L _{sd}	i = 1	i = 2	E	K	F
MSK 076C	292.5 ¹⁾²⁾	140	90	70	519	350	348.5	77	140	

RV05, RV06

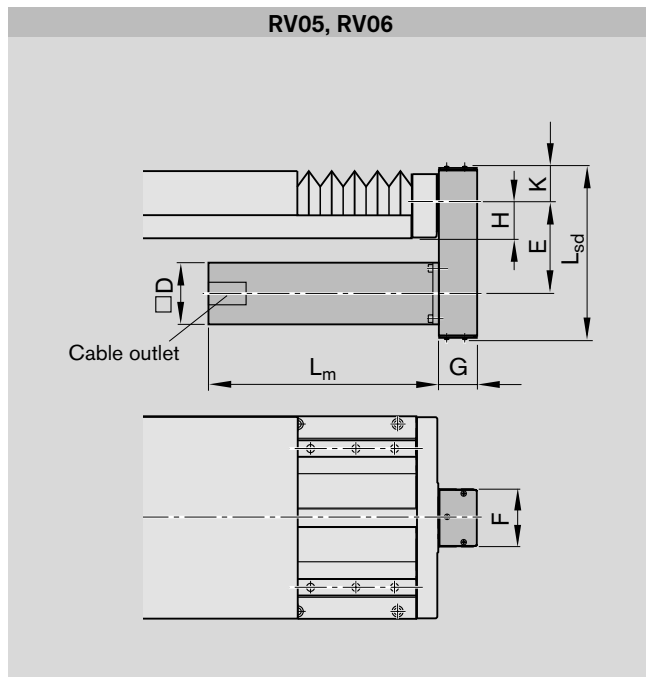

Motor	Dimensions (mm)								
	L _m	D	G	H	L _{sd}	i = 1	i = 2	E	K
MSK 076C	292.5 ¹⁾²⁾	140	90	70	409	239	238	77	

- 1) Without brake
- 2) With brake

For motor dimensions, see "Motors."

Note for multi-axis units

(e.g. X-Y tables)

For multi-axis units with motor attachment via timing belt side drive, the motor may project into the working area of adjacent axes. Check for any interference contours.

Switch Mounting Arrangements

Overview of switching system

Accessories:

- 1 Mechanical switch, external
- 2 Switching cam
- 3 Proximity switch, external
- 4 Socket-plug for external switches
- 5 Mechanical and proximity switches, internal
- 6 Socket-plug for internal switches
- 7 Profiled support

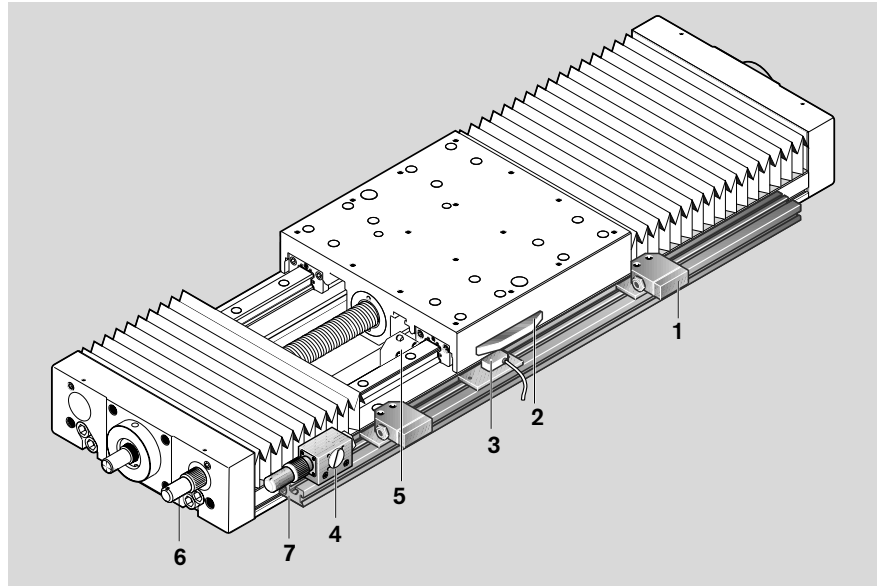

Mechanical switch, internal

Reproducibility	= ± 0.05 mm
Permissible ambient temperature	= -5 °C to $+80$ °C
Enclosure protection class	= DIN 40050 IP 67
Contact time	= < 2 ms
Insulation	= group C to VDE 0110
Rated voltage	= 250 V AC
Continuous current	= 5 A
Switching capacity at 220 V, 40-60 Hz	= $\cos\phi = 0.8$ at 2 A
Contact resistance when new	= < 240 m Ω
Connection	= soldered connection
Contact system	= single-pole changeover
Switch system	= snap-action

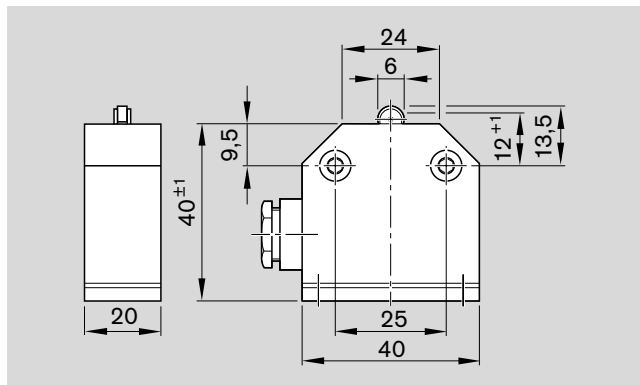

Mechanical switch, external

Reproducibility	= ± 0.05 mm
Permissible ambient temperature	= -5 °C to $+80$ °C
Enclosure protection class	= DIN 40050 IP 67
Contact time	= < 2 ms
Insulation	= group C to VDE 0110
Rated voltage	= 250 V AC
Continuous current	= 5 A
Switching capacity at 220 V, 40-60 Hz	= $\cos\phi = 0.8$ at 2 A
Contact resistance when new	= < 240 m Ω
Connection	= screw connection
Contact system	= single-pole changeover
Switch system	= snap-action

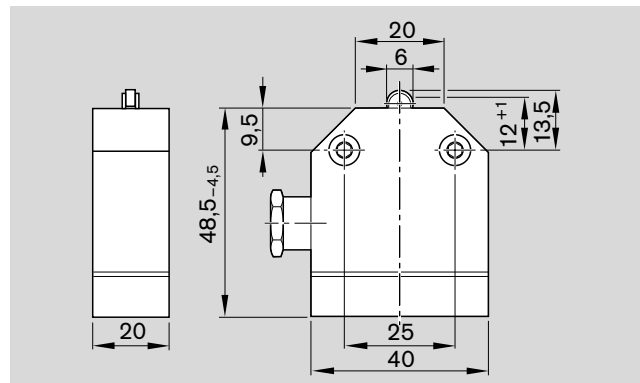

Proximity switch, internal or external

Miniature circuit-breakers with potted cable
(3 x 0.14 mm² Unitronic)

Housing form	= NO
Minisensor	= Form A DIN 41635
Voltage	= 10...30 V DC
Residual ripple	= ≤ 10 %
Load	= 200 mA
No-load current	= ≤ 20 mA
Switching frequency	= max. 1500 Hz
Temperature-related shift in make point	= ≤ 4 μm/°C
Output signal steepness	= ≥ 1 V/μs
Repeatability of make point per EN 50008	= ≤ 0.1 mm

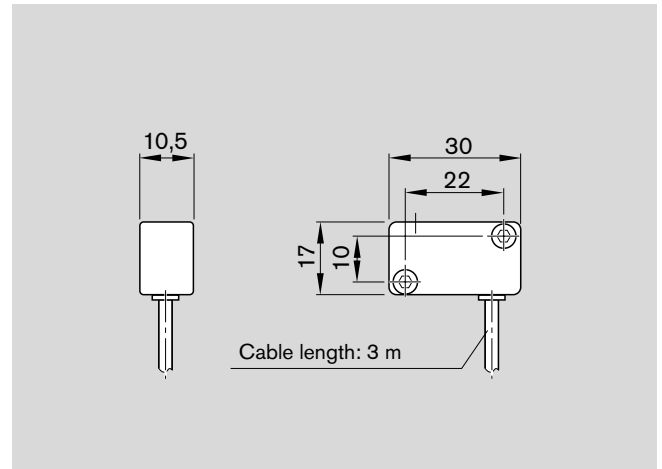
**End-plate-mounted socket and plug for internal switches**

- The socket and plug each have 16 pins.
- The socket and switch are pre-wired.
- A plug is provided.

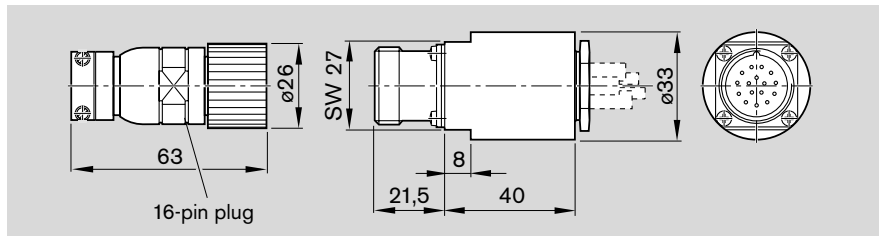
**Externally mounted socket and plug for external switches**

- The socket and plug each have 16 pins.
- The socket and switch are not pre-wired. The switch activation points can thus be optimized during start-up.
- A plug is provided.

The plug can be mounted in three directions (see diagram).

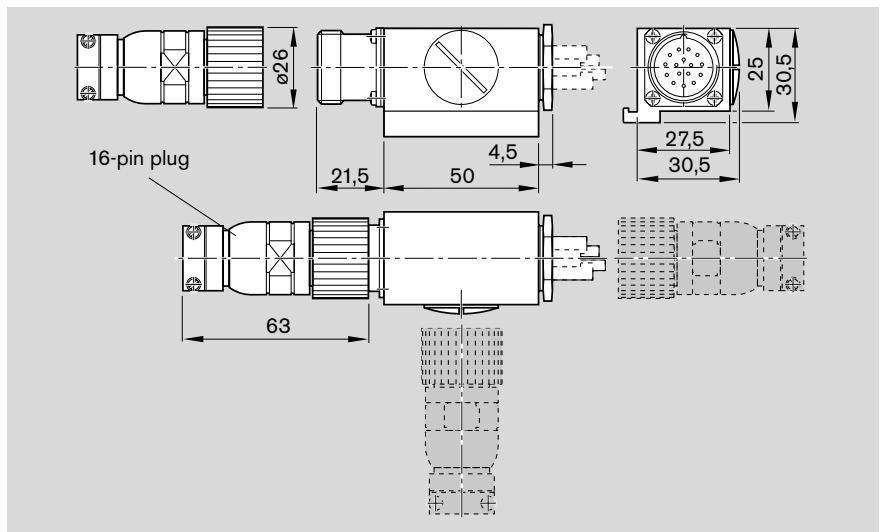
**Cable duct**

- The cable duct will accommodate up to two cables for mechanical switches and three cables for proximity switches.
- The duct is fixed by clipping it into the T-slot on the table and is secured by tightening the fixing screws.
- The fixing screws and cable gromets are supplied with the duct.

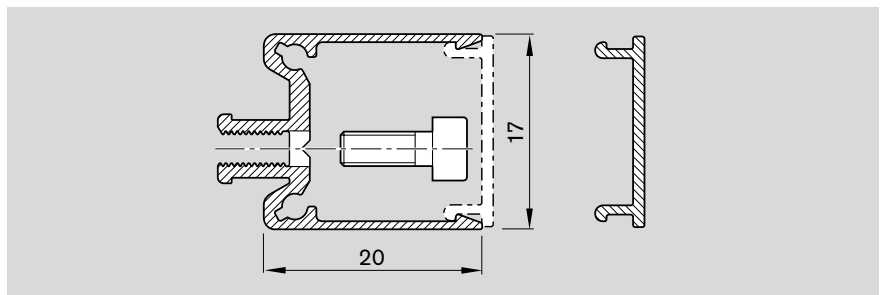

Motors

AC servo motors

Notes

All MSK motors have an absolute multi-turn encoder (Hyperface, 128 increments with 4096 revolutions).

The motors can be supplied complete with controller and control unit.
For more detailed information on motors and control systems, please refer to the catalogs "ECODRIVE Cs" and "IndraDrive for Linear Motion Systems."

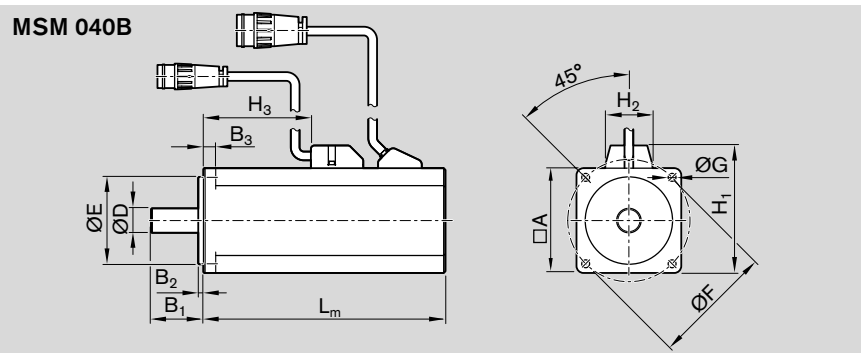
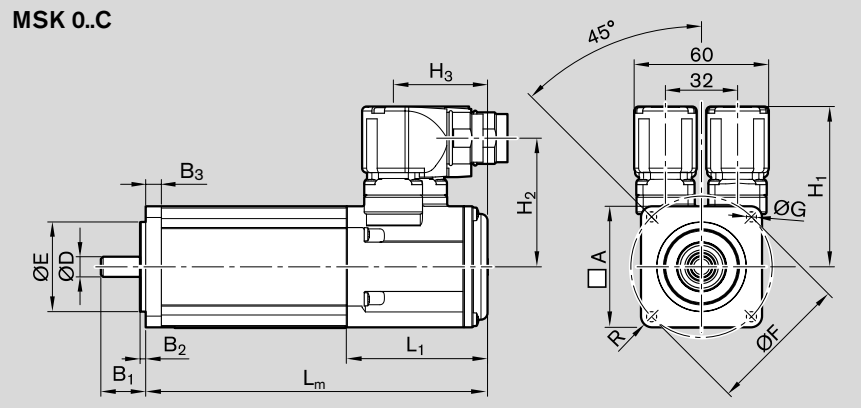

Motor type	Dimensions (mm)														L _m		L ₁	R	
	A	B ₁	B ₂	B ₃	k6	ØD	h6	j6	ØE	h7	ØF	ØG	H ₁	H ₂	H ₃	without brake			with brake
MSK 040C	82	30	2.5	8.0	14		50		95	6.6	83.5	69.0	31.0			185.5	215.5	42.5	R8
MSK 050C	98	40	3.0	9.0	19		95		115	9.0	85.5	71.0	43.5			203.0	233.0	55.5	R8
MSK 060C	116	50	3.0	9.5	24		95		130	9.0	98.0	84.0	37.0			226.0	259.0	48.0	R9
MSK 076C	140	50	4.0	10.0	24		110		165	11.0	110.0	95.6	57.5			292.5	292.5	79.0	R12
MSM 040B	80	35	3.0	6.0		19		70	90	6.0	93.0	27.0	76.0			157.5	191.5	-	-

Motor data, AC servo motors

Motor type	Symbol	Unit	MSK 040C	MSK 050C	MSK 060C	MSK 076C	MSM 040B
Maximum usable speed	n _{max}	(min ⁻¹)	6000	6000	6000	5000	⚡
Rated torque	M _N	(Nm)	2.7	5.0	8.0	12.0	2.4
Maximum torque	M _{max}	(Nm)	8.1	15.0	24.0	43.5	⚡
Mass moment of inertia	J _m + J _{br}	(10 ⁻⁶ kgm ²)	140 + 23	330 + 107	800 + 55	4300 + 360	67.0 + 8.0
Brake holding torque	M _{br}	(Nm)	4.0	5.0	10.0	11.0	-
Mass of brake	m _m + m _{br}	(kg)	0.32	0.70	0.45	13.8 + 1.1	3.1 + 0.7

⚡ Refer to the "ECODRIVE Cs" and "IndraDrive for Linear Motion Systems" catalogs.

3-phase stepping motors

Notes

All VRDM motors are equipped with an encoder for rotation monitoring.

The motors can be supplied complete with controller and control unit. For more information on motors, controllers and control systems, please refer to the catalogs "ECODRIVE Cs" and "IndraDrive for Linear Motion Systems."

Key to illustration

- 1 Motor connector
- 2 Brake
- 3 Encoder connector
- 4 Brake connector

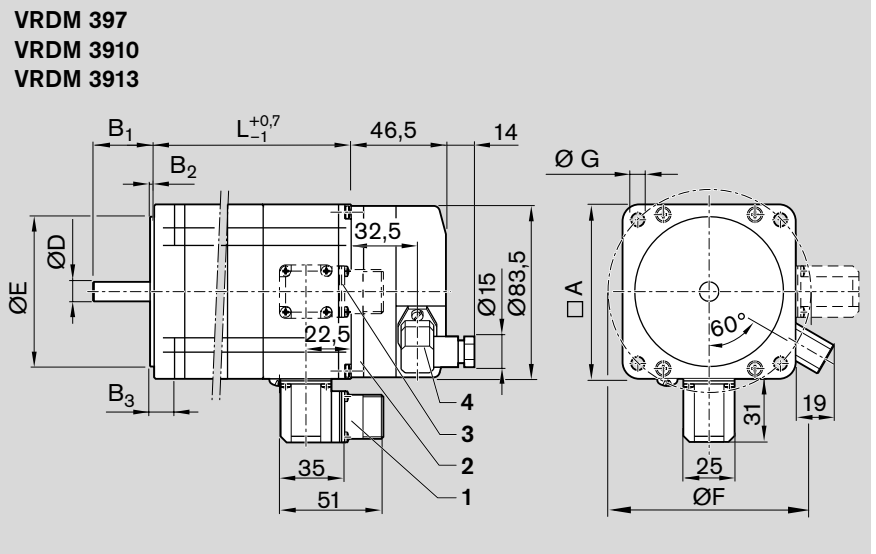

Motor	Dimensions (mm)				ØD	ØE	ØF	ØG	L	
	A	B ₁	B ₂	B ₃					without brake	with brake
VRDM 397	85.0	30	2.0	10	12 _{h6}	60.0 _{h8}	99.0	6.5	110.0	156.5
VRDM 3910	85.0	30	2.0	10	12 _{h6}	60.0 _{h8}	99.0	6.5	140.0	186.5
VRDM 3913	85.0	30	2.0	10	12 _{h6}	60.0 _{h8}	99.0	6.5	170.0	216.5

Motor data

Motor	Symbol	Unit	VRDM 397	VRDM 3910	VRDM 3913
Maximum permissible torque	M_{max}	(Nm)	2.00	4.00	6.0
Motor mass moment of inertia	J_m	(10^{-6} kgm ²)	110	220	330
Motor holding torque	M_m	(Nm)	2.26	4.52	6.78
Mass without brake	m_m	(kg)	2.5	3.1	4.2
Step count	z	(-)	200 / 400 / 500 / 1000 / 2000 / 4000 / 5000 / 10000		
Stepping angle per step	α	(°)	1.8 / 0.9 / 0.72 / 0.36 / 0.18 / 0.09 / 0.072 / 0.036		
Encoder resolution			1000 increments/revolution		
Holding brake					
Brake holding torque	M_{br}	(Nm)	6	6	6
Brake mass moment of inertia	J_{br}	(10^{-6} kgm ²)	20	20	20
Mass of brake	m_{br}	(kg)	1.5	1.5	1.5

Accessories

Documentation

Standard report Option 01

The standard report serves to confirm that the checks listed in the report have been carried out and that the measured values lie within the permissible tolerances.

Checks listed in the standard report:

- functional checks of mechanical components
- functional checks of electrical components
- design is in accordance with order confirmation

Frictional moment of complete system Option 02

The moment of friction is measured over the entire travel range.

Example

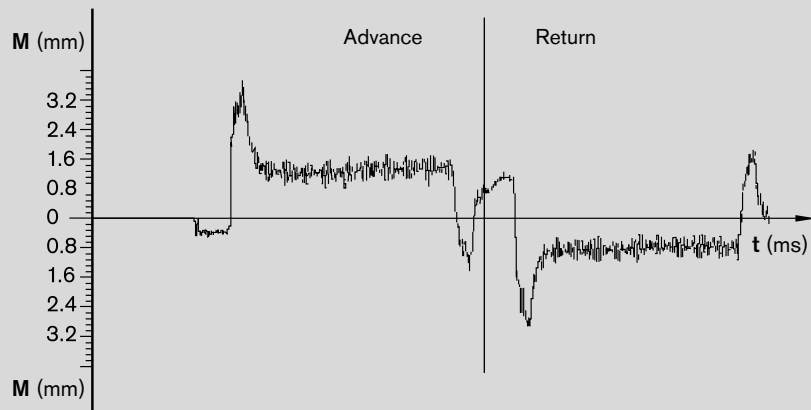

Lead deviation of ball screw Option 03

A measurement report in table form is provided in addition to the graph (see illustration).

Example

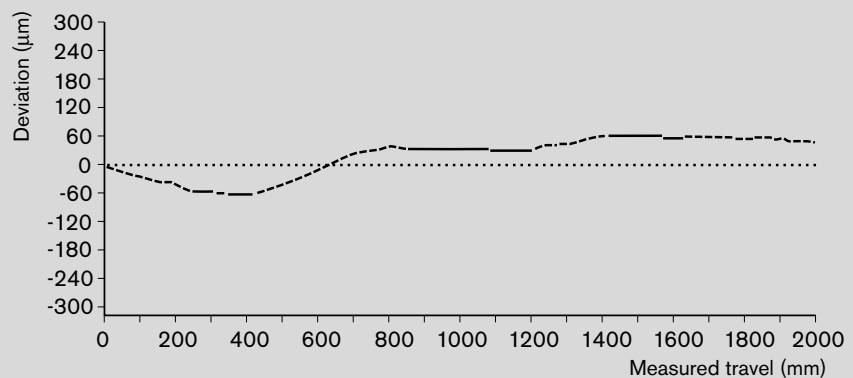

**Travel accuracy
Option 04**

Several measuring points are passed during the total travel. The following deviations are determined:

Note: The measurements are taken with the unit screwed down and assuming an ideally flat mounting base surface.

Yawing

Yawing is angular deviation about the Z-axis. This angular deviation is converted to a linear deviation in μm on the basis of a standard length and is plotted on the graph. The base length is given in the graph.

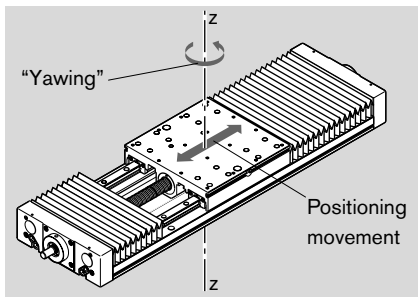

Example (Base length 100 mm)

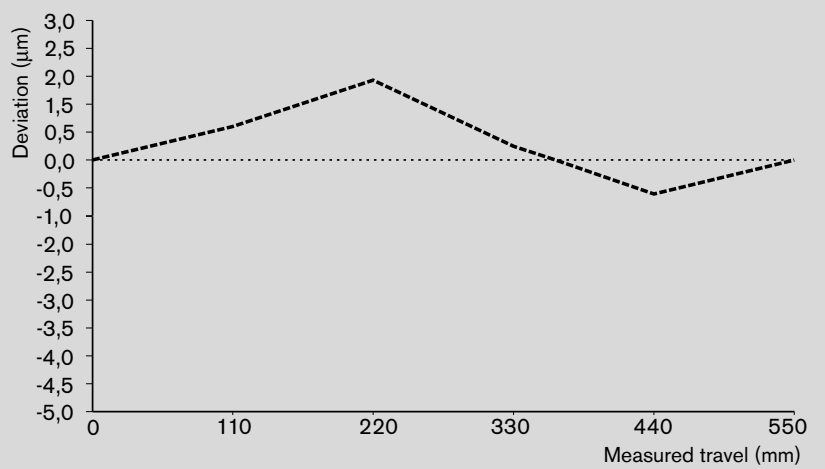

Pitching

Pitching means angular deviation about the Y-axis. This angular deviation is converted to a linear deviation in μm on the basis of a standard length and is plotted on the graph. The base length is given in the graph.

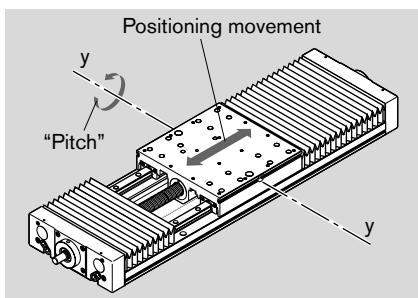

Example (Base length 100 mm)

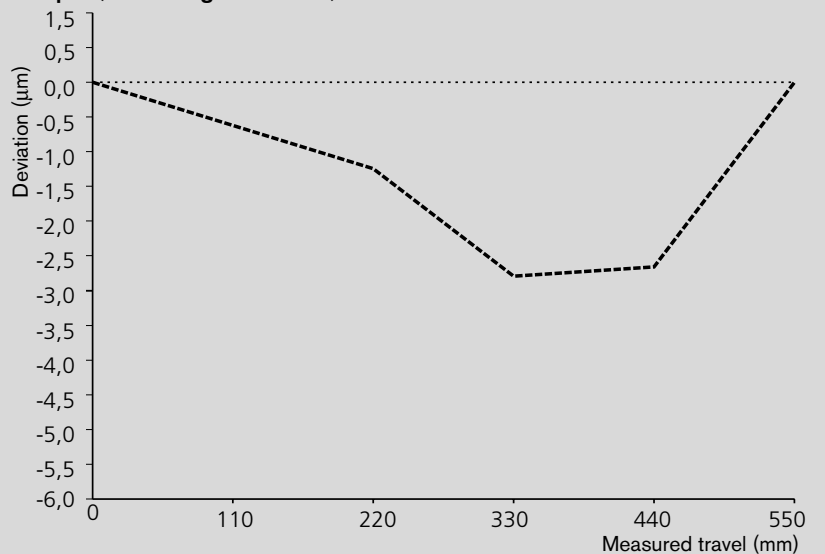

In addition to graphical representation (see illustrations), a measurement report is supplied in table form.

Accessories

Documentation

Positioning accuracy per VDI/DGQ 3441 Option 05

Measurement points are selected at irregular intervals along the travel range. This enables even periodical deviations to be detected during positioning. Each measurement point is approached several times from both sides. This gives the following parameters. This will give the following parameters. Note: The measurements are taken with the unit screwed down and assuming an ideally flat mounting base surface.

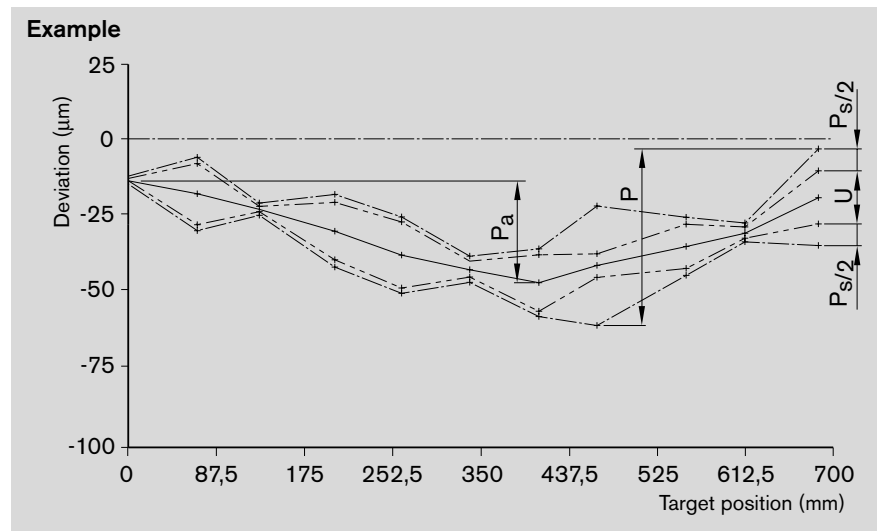

Positioning accuracy P

The positioning accuracy corresponds to the total deviation. It encompasses all the systematic and random deviations during positioning.

The positioning accuracy takes the following characteristic values into consideration:

- position deviation
- reversal range
- position variation range

Position deviation P_a

The position deviation corresponds to the maximum difference arising in the mean values of all the measurement points. It describes systematic deviations.

Reversal range U

The reversal range corresponds to the difference in mean values of the two approach directions. The reversal range is determined at every measurement point. It describes systematic deviations.

Position variation range P_s

The position variation range describes the effects of random deviations. It is determined at every measurement point.

Mounting accessories

TKK 15-155 Al

**TKK 20-225 Al
TKK 30-325 Al**

Part number R3447 001 01
Sliding block

Part number R0391 750 03
Sliding block

Part number R3447 010 02
Sliding block

TKK 35-455 Al

Part number R3447 006 01
Sliding block

Part number R3454 030 49
Fixing spring for sliding block

Part number R3447 006 01

Lubrication

Lube nipples in carriage

Basic lubrication is carried out by the manufacturer.

Ball Rail Tables are designed for grease lubrication (with a manual grease gun). The only maintenance required is relubrication via the lube nipples on the sides of the carriage.

Each carriage has 2 funnel-type lube nipples (1) per DIN 3405 AM8x1.

Lubrication via only one of the two lube nipples is sufficient.

Never use greases with solid lubricant components (e.g. graphite or MoS₂).

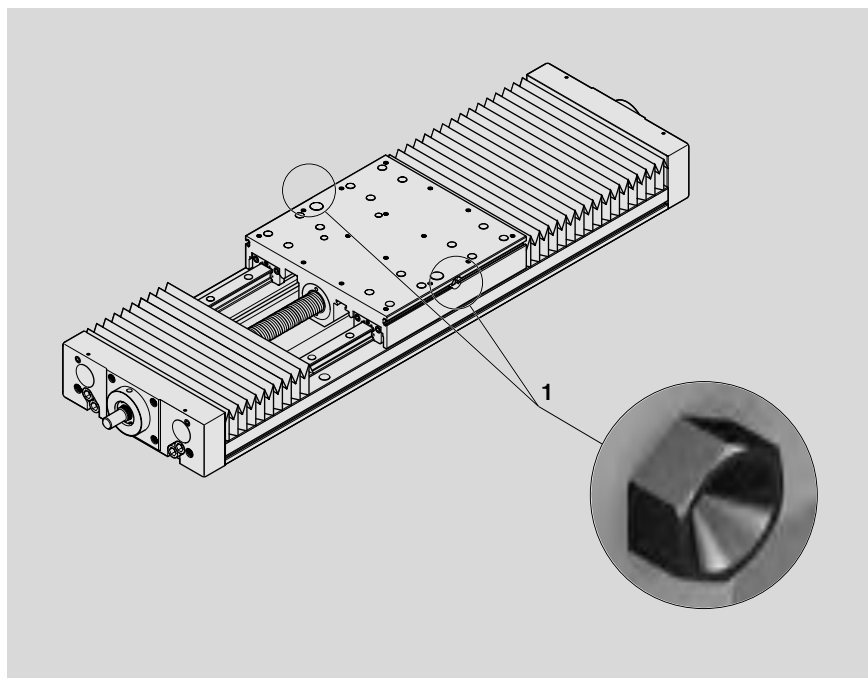

Recommended lithium soap greases:

For lubricant quantities and intervals, see "Mounting Instructions for Ball Rail Tables."



Grease	Consistency class	Recommended grease	Part number (400g cartridge)
DIN 51825	DIN 51818		
KP2K	NLGI 2	Dynalub 510	R3416 037 00

Connection System

Cross-plates have been designed for easy assembly of X-Y units. They are supplied as assembly kits containing all the screws, pins and sliding blocks required to join the two axes.

Same-size units can be combined.

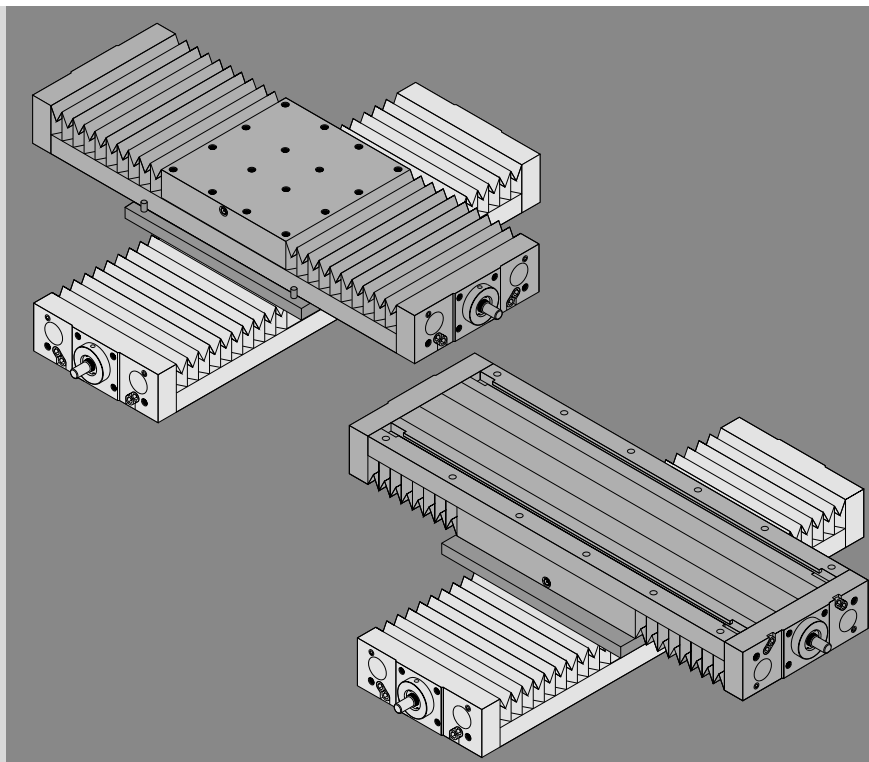

A unit can be combined with the next largest or smallest size.

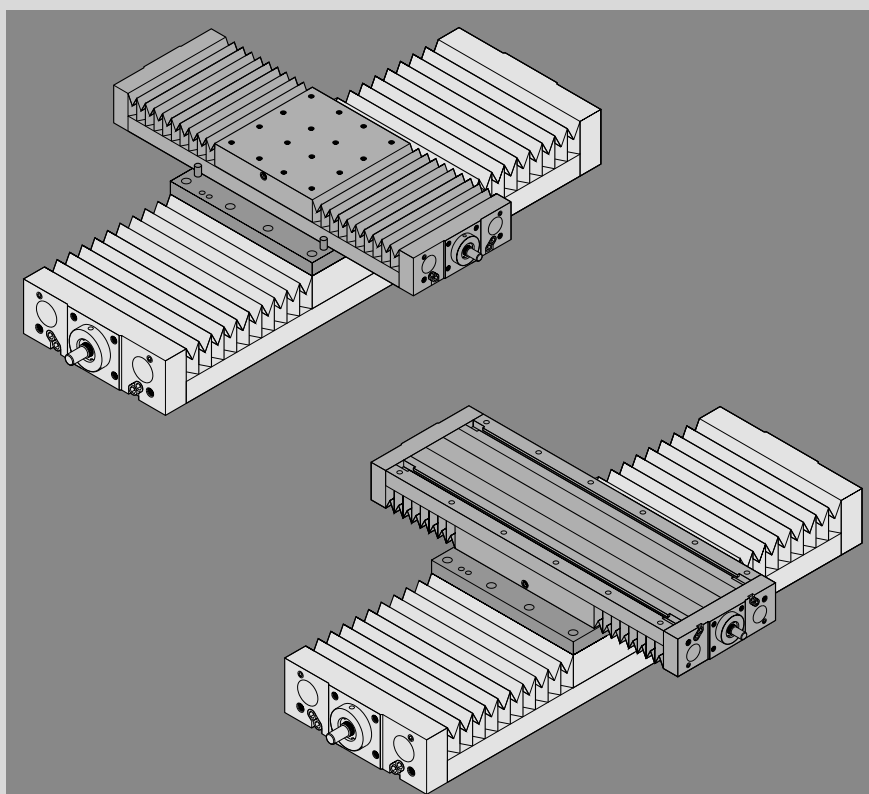

Connection System

General

In a two-axis unit, the accuracies of the individual axes and of the cross-plate are added, together with the elastic deformation of the Y-axis (not fully supported). However, this deformation can be significantly reduced by the use of the high base plate. The perpendicularities shown in the graphs are calculated maximum values and describe the angular relation of the two axes to each other. They are attained by simple joining and fixing together using existing or predrilled pin-holes, without requiring alignment. More precise perpendicularities can be produced by aligning the Y-axis and drilling the predrilled pin-holes in the cross-plate. The P4 accuracies of the individual axes must be added to the specified angularity.

Assemblies for connection of base plate to carriage

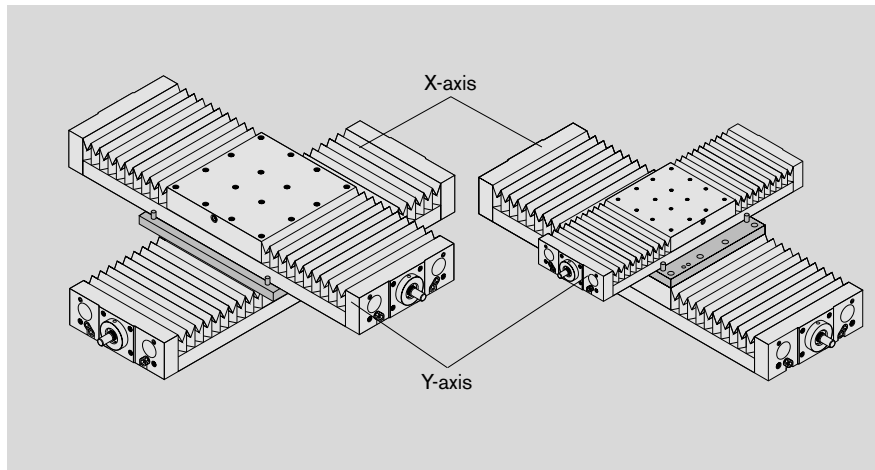

Part numbers of cross-plate assembly kits

Consisting of: cross-plate with all fixings required to join the two axes.

X-axis	Y-axis		
	TKK 15-155 AI	TKK 20-225 AI	TKK 30-325 AI
TKK 15-155 AI	R0391 200 11		
TKK 20-225 AI	R0391 200 13	R0391 200 15	
TKK 30-325 AI		R0391 200 17	R0391 200 19
TKK 35-455 AI			R0391 200 21

Perpendicularity of the two axes

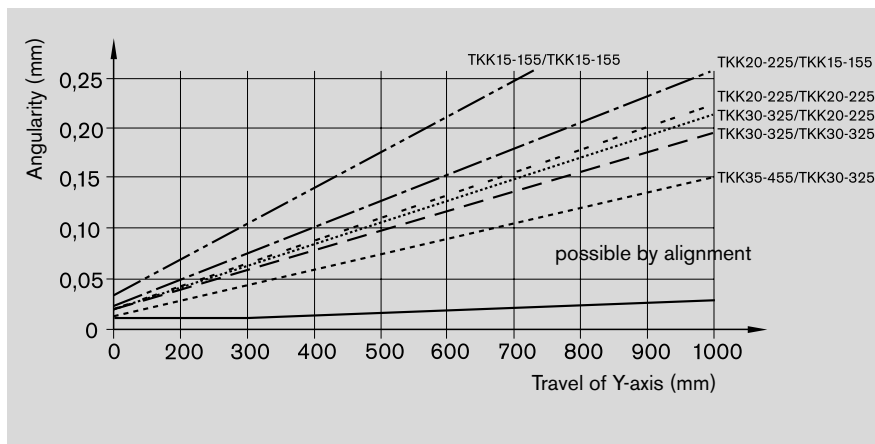

Note

Fully assembled cross-plates and combinations of steel Ball Rail Tables available on request.
 In the case of motor attachment via timing belt side drive, the motor may project into the working area of adjacent axes. Check for any interference contours.

Assemblies for connection of carriage to carriage

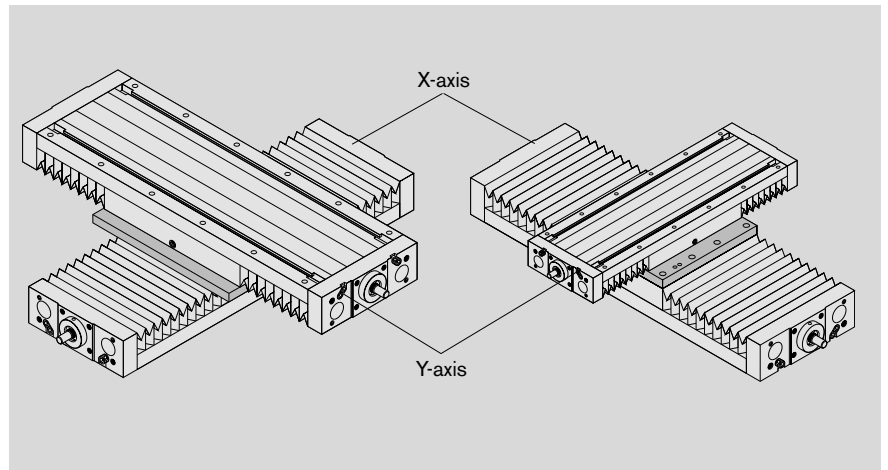

Part numbers of cross-plate assembly kits

Consisting of: cross-plate with all fixings required to join the two axes.

X-axis	Y-axis TKK 15-155 AI with $L_{ca} = 220$	TKK 20-225 AI with $L_{ca} = 320$	TKK 30-325 AI with $L_{ca} = 450$
TKK 15-155 AI	R0391 200 12		
TKK 20-225 AI	R0391 200 14	R0391 200 16	
TKK 30-325 AI		R0391 200 18	R0391 200 20
TKK 35-455 AI			R0391 200 22

L_{ca} = carriage length

Perpendicularity of the two axes

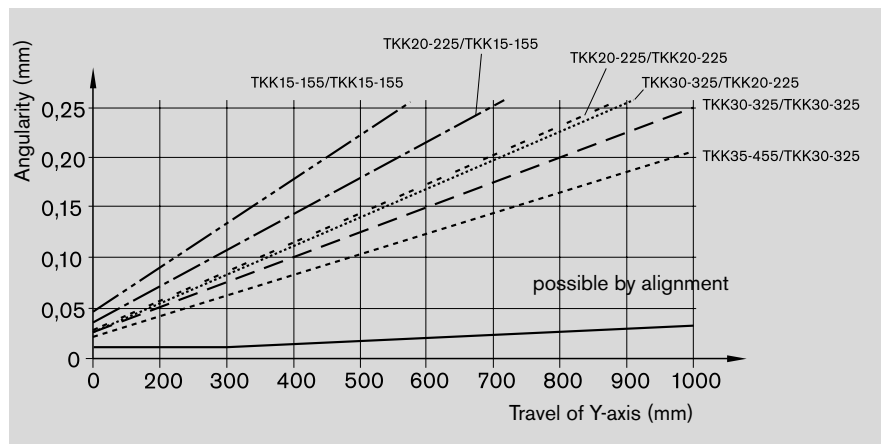

Connection System

Dimensions of the cross-plates when connecting Ball Rail Tables of the same size

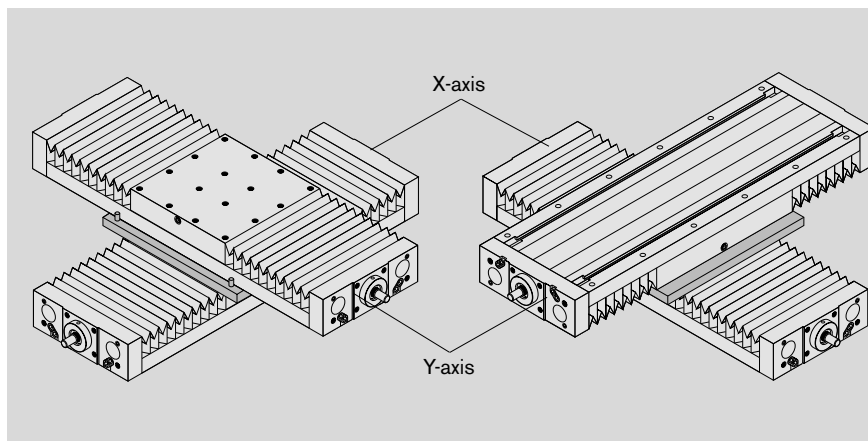

- 1 Pin-holes for joining the Y-axis in base-plate to carriage combinations
- 2 Pre-drilled pin-holes for pinning the Y-axis in base-plate to carriage combinations
- 3 X-axis centerline
- 4 Y-axis centerline

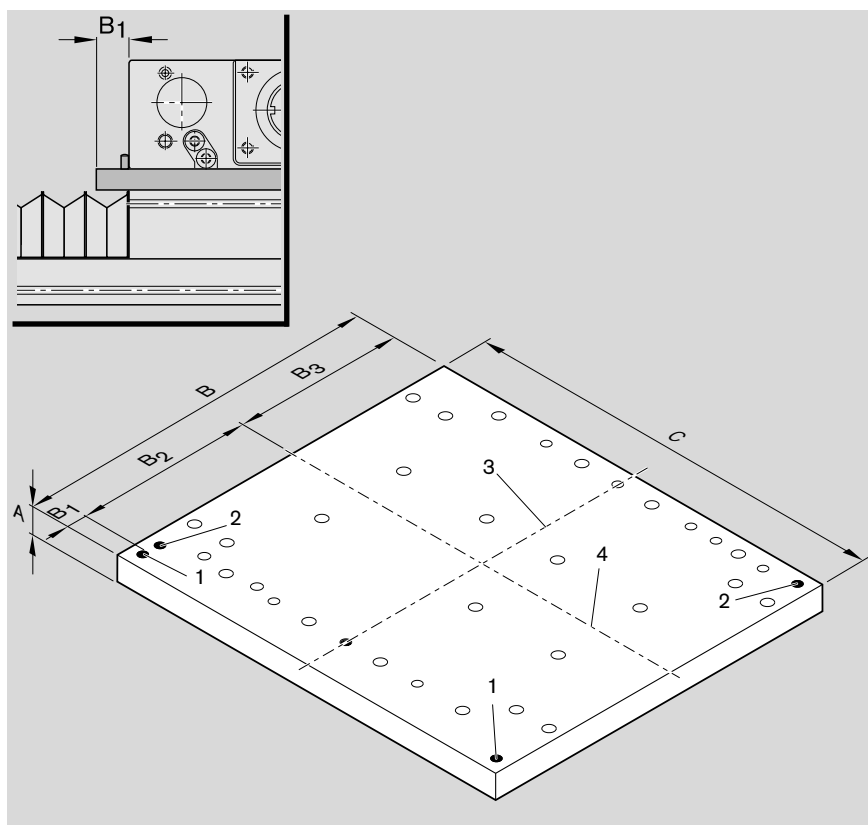

Part number of assembly kit	Dimensions (mm)					
	A	B	C	B ₁	B ₂	B ₃
R0391 200 11	18	165	220	11	77.5	76.5
R0391 200 12						
R0391 200 15	18	240	320	16	112.5	111.5
R0391 200 16						
R0391 200 19	25	340	450	16	162.5	161.5
R0391 200 20						

Dimensions of the cross-plates when connecting Ball Rail Tables to next largest or next smallest size

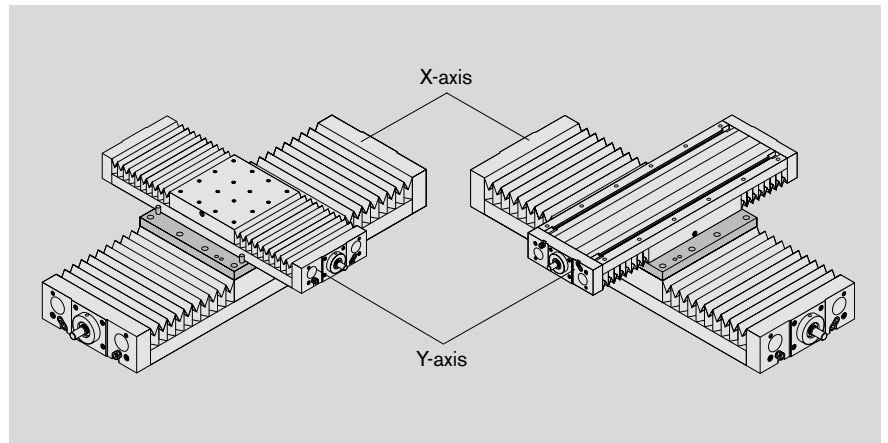

- 1 Pin-holes for joining the Y-axis in base-plate to carriage combinations
- 2 Pre-drilled pin-holes for pinning the Y-axis in base-plate to carriage combinations
- 3 X-axis centerline
- 4 Y-axis centerline

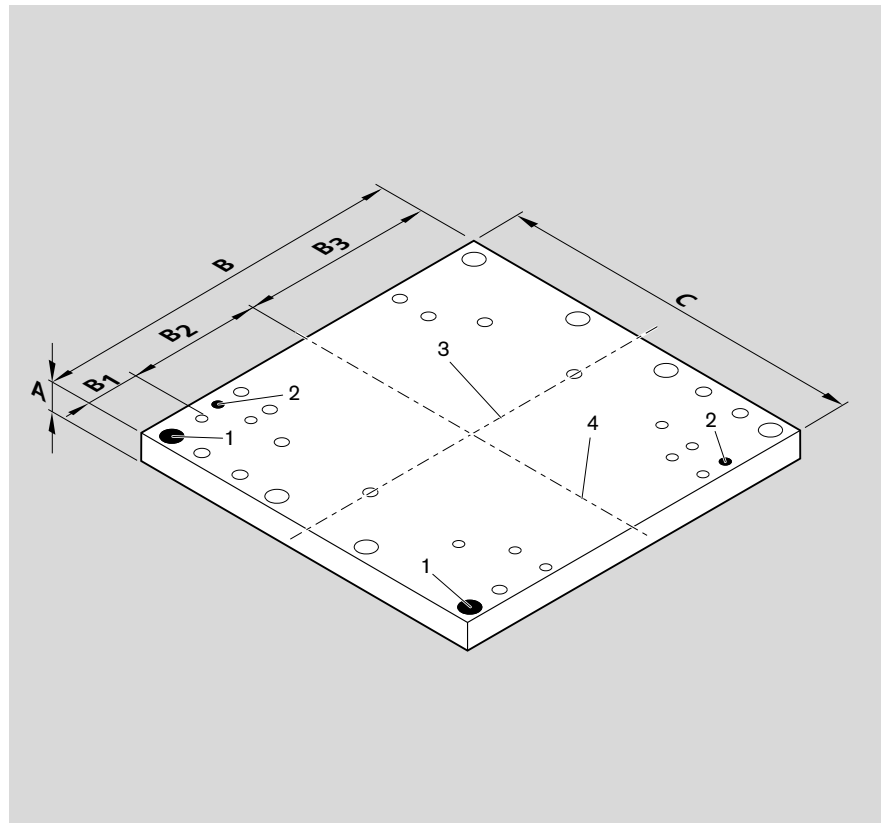

Part number of assembly kit	Dimensions (mm)					
	A	B	C	B ₁	B ₂	B ₃
R0391 200 13	18	220	220	32.5	77.5	110
R0391 200 14	18	320	320	47.5	112.5	160
R0391 200 17						
R0391 200 18						
R0391 200 21	25	400	450	37.5	162.5	200
R0391 200 22						

Order Example

Ordering data	Description
Ball Rail Table	Ball Rail Table
(Part number): R1460 300 00, 1660 mm	TKK 20-225 St R1460 300 00, 1660 mm
Type = RV04	With timing belt side drive, mounted, as shown in diagram RV04
Guideway = 01	Base plate, low
Drive unit = 09	Ball screw 20 x 20 (drive via floating bearing journal ø14)
Carriage = 01	One carriage 220 mm long, preload 2%
Motor attachment = 54	Timing belt side drive for motor MSK 050C, i = 2
Motor = 89	Motor MSK 050C
Cover = 01	PU bellows
Position measuring system = 00	Without glass scale
1st switch = 15-A + 500 mm	Mechanical switch, external, switch activation point + 500 mm
2nd switch = 11-A ± 0 mm	PNP NC, external, switch activation point ± 0 mm
3rd switch = 15-A - 500 mm	Mechanical switch, external, switch activation point - 500 mm
Cable duct = 20-X 1500 mm	Cable duct 1500 mm long (loose)
Socket/plug = 17	Socket/plug (loose)
Switching cam = 26	With external switching cam (for switch activation)
Documentation = 01	With standard report

Please check whether the selected combination is a permissible one (load capacities, moments, maximum speeds, motor data, etc.)!

Length of the Ball Rail Table

$$\begin{aligned}
 \text{Excess travel} &= 2 \cdot P = 2 \cdot 20 \text{ mm} = 40 \text{ mm} \\
 \text{Effective stroke} &= \text{max. travel} - 2 \cdot \text{excess travel} \\
 \text{Max. travel} &= \text{stroke}_{\text{eff}} + 2 \cdot \text{excess travel} \\
 &= 1134 \text{ mm} + 2 \cdot 40 \text{ mm} \\
 &= 1214 \text{ mm} \\
 L &= 1660 \text{ mm for max. travel} = 1214 \text{ mm} \\
 &\text{from data sheet TKK 20-225 St}
 \end{aligned}$$

For safe operation, the excess travel must be longer than the braking distance. The acceleration travel can be taken as a guideline value for the braking distance. In most cases, 2x the ball screw lead (P) will be sufficient.

Example for P = 20 mm:

Excess travel (braking distance) ≈ 40 mm

Switch mounting arrangements

A profiled support is required for mounting the switches.

Switches may only be mounted to one side of the Ball Rail Table (left or right).

Refer to the section on "Switch Mounting Arrangements" for more information on switch types and switch mounting.

Inquiry/Order Form

Bosch Rexroth AG
Linear Motion and Assembly Technologies
 D-97419 Schweinfurt
 Germany

Telephone +49-9721-937-0

Telefax +49-9721-937-350
 (direct)

Ball Rail Tables TKK

To be completed by customer: Inquiry / Order

Ball Rail Table TKK _____
 (Part number): _____ - _____ - _____, length _____ mm

Type	=	<input type="checkbox"/>	<input type="checkbox"/>	<input type="checkbox"/>	<input type="checkbox"/>	
Guideway	=	<input type="checkbox"/>	<input type="checkbox"/>			
Drive unit	=	<input type="checkbox"/>	<input type="checkbox"/>			
Carriage	=	<input type="checkbox"/>	<input type="checkbox"/>			
Motor attachment	=	<input type="checkbox"/>	<input type="checkbox"/>			
Motor	=	<input type="checkbox"/>	<input type="checkbox"/>			
Cover	=	<input type="checkbox"/>	<input type="checkbox"/>			
Position measuring system	=	<input type="checkbox"/>	<input type="checkbox"/>			
1st switch	=	<input type="checkbox"/>	<input type="checkbox"/>	<input type="checkbox"/>	<input type="checkbox"/>	mm
2nd switch	=	<input type="checkbox"/>	<input type="checkbox"/>	<input type="checkbox"/>	<input type="checkbox"/>	mm
3rd switch	=	<input type="checkbox"/>	<input type="checkbox"/>	<input type="checkbox"/>	<input type="checkbox"/>	mm
Cable duct	=	<input type="checkbox"/>	<input type="checkbox"/>	<input type="checkbox"/>	<input type="checkbox"/>	mm
Socket/plug	=	<input type="checkbox"/>	<input type="checkbox"/>			
Switching cam	=	<input type="checkbox"/>	<input type="checkbox"/>			
Documentation	=	<input type="checkbox"/>	<input type="checkbox"/>			

Please check whether the selected combination is a permissible one (load capacities, moments, maximum speeds, motor data, etc.)!

Quantity Order of _____ pcs, _____ per month, _____ per year, per order, or _____
 Comments: _____

From

Company: _____ Name: _____
 Address: _____ Department: _____
 _____ Telephone: _____
 _____ Telefax: _____

Inquiry/Ordering data for multi-axis units

X-Y table supplied as separate components (for assembly by customer)

- Consisting of:
- X-axis, see order example
 - Y-axis, see order example
 - Cross-plate assembly kit

Fully assembled X-Y table on request

Bosch Rexroth AG
Linear Motion and
Assembly Technologies
Ernst-Sachs-Straße 1000
97424 Schweinfurt, Germany
Tel. +49 9721 937-0
Fax +49 9721 937-275
www.boschrexroth.com/brl

Australia

Bosch Rexroth Pty. Ltd.
3 Valediction Road
Kings Park, NSW 2148, Sydney
Tel. +61 2 9831 7788
Fax +61 2 9831 5553

Great Britain

Bosch Rexroth Limited
Cromwell Road
St. Neots, Huntingdon
Cambs. PE19 2ES
Tel. +44 1480 223 298
Fax +44 1480 470 789

Canada

Bosch Rexroth Canada Corp.
3426 Mainway Drive
Burlington, Ontario L7M 1A8
Tel. +1 905 335-5511
Fax +1 905 335-4184

USA

Bosch Rexroth Corporation
14001 South Lakes Drive
Charlotte, NC 28273
Tel. +1 800 REXROTH
+1 800 739 7684
Fax +1 704 583 0523

Singapore

Bosch Rexroth Pte. Ltd.
15D Tuas Road
638520 Singapore
Tel. +65 6861 8733
Fax +65 6861 1825

Your sales partner

Subject to technical modifications